



MILLWORK CATALOG

DOORS

2025 EDITION



TABLE OF CONTENTS

INTERIOR DOORS*

CLEAR PINE	
INTERIORS	11
HOLLOW CORE	
SLABS & BI-FOLDS	6
KNOTTY PINE	
INTERIORS	12
MDF	
SLABS	10
POCKET FRAMES	
INTERIORS	13
SOLID CORE	
SLABS	8

EXTERIOR DOORS*

FIBERGLASS DOORS	
OPAQUE SLABS	16
1 LITE	17
BLINDS	18
EXTERNAL GRIDS	19
INTERNAL GRIDS	20
NOUVEAU	22
TEXAS STAR	23
MISC	24
FLUSH GLAZED (VISTA GRANDE)	26
PRE-FINISHED (SIGNAMARK)	27
METAL DOORS	
OPAQUE SLABS	28
1 LITE	29
BLINDS	30
EXTERNAL GRIDS	31
INTERNAL GRIDS	32
NOUVEAU	33
TEXAS STAR	34
MISC	35
WOOD DOORS	
MAHOGANY/KNOTTY ALDER	36

DOOR COMPONENTS*

DOOR COMPONENTS	
DOOR HINGE OPTIONS / VENTS	40
INTERIOR/EXTERIOR JAMBS	41
SILLS	42
SILLS & SILL COMPONENTS	43
PANOLOCK MULTI-POINT LOCK	44
LIGHTEN IN-FRAME LIGHT	46
WOOD DOOR ACCESSORIES / PET DOOR	48

DOOR INFORMATION

DOOR HANDING GUIDE	
INSWING	52
OUTSWING	53
MOLDED DOOR CUTDOWN RANGES	
JELD-WEN	54
SIZES & ROUGH OPENINGS	
INTERIOR DOOR UNITS	50

GLASSCRAFT®

BARNCRAFT®	
SLIDING DOORS	62
FIBERCRAFT®	
COMPOSITE DOORS	60
WOODCRAFT®	
HARDWOOD DOORS	61

PATIO DOORS

ATRIUM	
SERIES 312 - SLIDING PATIO DOOR	66
SERIES 332 - SLIDING PATIO DOOR	67
MI WINDOWS & DOORS	
V2000 PATIO DOOR	68
V3000 MULTI-SLIDE PATIO DOOR	70
SHOWCASE	
MULTI-PANEL SLIDING PATIO DOOR	72

PREMIUM PATIO DOORS

BONELLI	
MULTI-SLIDE PATIO DOOR	78
PIVOT PATIO DOOR	79
MI WINDOWS & DOORS	
V3000 MULTI-SLIDE PATIO DOOR	76
NEUMA DOORS	
PATIO DOORS	74
WINDOR	
3750 MULTI-SLIDE SYSTEM	75

IRON DOORS

IRON ENVY	
IRON DOORS	82

COMMERCIAL DOORS

TELL	
SPARTAN HOLLOW METAL DOORS	86

ABBREVIATION LEGEND	91
----------------------------------	----

*In stock at the McCoy's Door Shop for quick ship to the McCoy's Store.





DOOR & MILLWORK

INTERIOR DOORS

HOLLOW CORE

SLABS & BI-FOLDS



SLABS

SIZE	THICKNESS	1 PNL MADISON	2 PNL RND TOP SANTA FE	2 PNL SQ CARRARA	2 PNL RND TOP CAIMAN	2 PNL ARCH CAMDEN	2 PNL MONROE	3 PNL BIRKDALE	3 PNL BEVELED CRAFTSMAN	5 PNL ROCKPORT	6 PNL ROCKPORT	6 PNL COLONIST	HARD- BOARD	LAUAN	BIRCH
1'0 X 6'8	1-3/8"		•	•	•	◇		•	•			+	•		
1'10 X 6'8	1-3/8"			•								◇			
1'2 X 6'8	1-3/8"		•	•	•	◇		•				+	•		
1'3 X 6'8	1-3/8"		•	•	•	◇		•				+	•		•
1'4 X 6'8	1-3/8"		•	•	•	◇		•		•		+	•	•	•
1'6 X 6'8	1-3/8"	•	•	•	•	◇	•	•	•	•		+	•	•	•
1'8 X 6'8	1-3/8"		•	•	•	◇				•		+	•	•	•
2'0 X 6'8	1-3/8"	•	•	•	•	◇	•	•	•	•		+	•	•	•
2'4 X 6'8	1-3/8"	•	•	•	•	◇	•	•	•	•		+	•	•	•
2'6 X 6'8	1-3/8"	•	•	•	•	◇	•	•	•	•		+	•	•	•
2'8 X 6'8	1-3/8"	•	•	•	•	◇	•	•	•	•		+	•	•	•
2'10 X 6'8	1-3/8"		•	•		◇						◇		•	
3'0 X 6'8	1-3/8"	•	•	•	•	◇	•	•	•	•		+	•	•	•
1'3 X 8'0	1-3/8"		•												
1'4 X 8'0	1-3/8"		•	•	•						•				
1'6 X 8'0	1-3/8"	•	•	•	•		•	•			•	◇			
1'8 X 8'0	1-3/8"		•												
2'0 X 8'0	1-3/8"	•	•	•	•		•	•			•	◇			
2'4 X 8'0	1-3/8"	•	•	•	•		•	•			•	◇			
2'6 X 8'0	1-3/8"	•	•	•	•		•	•			•	◇			
2'8 X 8'0	1-3/8"	•	•	•	•		•	•			•	◇			
3'0 X 8'0	1-3/8"	•	•	•	•		•	•			•	◇			
2'6 X 6'7	1-3/4"												•		
2'8 X 6'7	1-3/4"												•		
3'0 X 6'7	1-3/4"												•		
2'6 X 7'11	1-3/4"												•		
2'8 X 7'11	1-3/4"												•		
3'0 X 7'11	1-3/4"												•		
3'6 X 7'11	1-3/4"												•		

BI-FOLDS

SIZE	THICKNESS	2 PNL SANTA FE	2 PNL SQ CARRARA	2 PNL RND TOP CAIMAN	2 PNL ARCH CAMDEN	3 PNL BEVELED CRAFTSMAN	6 PNL COLONIST	HARDBOARD	LAUAN	BIRCH
2'0 X 6'8	1-3/8"	•	•	•	◇	•	+	•	•	•
2'4 X 6'8	1-3/8"						◇			
2'6 X 6'8	1-3/8"	•	•	•	◇	•	+	•	•	•
2'8 X 6'8	1-3/8"		•	•	◇		◇		•	
3'0 X 6'8	1-3/8"	•	•	•	◇	•	+	•	•	•

• SMOOTH OPTION ONLY ◇ TEXTURED OPTION ONLY + BOTH OPTIONS



1 PANEL
MADISON



2 PANEL ROUND
TOP SANTA FE



2 PANEL SQUARE
CARRARA



2 PANEL ROUND
TOP CAIMAN



2 PANEL ARCH
CAMDEN



2 PANEL
MONROE



3 PANEL
BIRKDALE



3 PANEL BEVELED
CRAFTSMAN



5 PANEL
ROCKPORT



6 PANEL
ROCKPORT



6 PANEL
COLONIST



HARDBOARD



LAUAN



BIRCH



2 PANEL BI-FOLD
SANTA FE



2 PANEL SQUARE
BI-FOLD CARRARA



2 PANEL ROUND TOP
BI-FOLD CAIMAN



2 PANEL ARCH
BI-FOLD CAMDEN



3 PANEL BI-FOLD
BIRKDALE



3 PANEL BEVELED
BI-FOLD
CRAFTSMAN



6 PANEL BI-FOLD
COLONIST



HARDBOARD
BI-FOLD



LAUAN
BI-FOLD



BIRCH
BI-FOLD

SOLID CORE SLABS



SIZE	THICKNESS	1 PNL MADISON	2 PNL RND TOP SANTA FE	2 PNL SQ CARRARA	2 PNL RND TOP CAIMAN	2 PNL ARCH CAMDEN	2 PNL MONROE	3 PNL BIRKDALE	3 P FLT/BV CRAFTSMAN	5 PNL ROCKPORT	6 PNL ROCKPORT	6 PNL COLONIST	HARD- BOARD	LAUAN	BIRCH
1'0 X 6'8	1-3/8"														
1'10 X 6'8	1-3/8"														
1'2 X 6'8	1-3/8"														
1'3 X 6'8	1-3/8"														
1'4 X 6'8	1-3/8"														
1'6 X 6'8	1-3/8"	•	•	•	•		•			•					
1'8 X 6'8	1-3/8"														
2'0 X 6'8	1-3/8"	•	•	•	•		•			•			•		•
2'4 X 6'8	1-3/8"	•	•	•	•		•			•			•		•
2'6 X 6'8	1-3/8"	•	•	•	•		•			•			•		•
2'8 X 6'7	1-3/4"	•	•	•	•	+	•	•	•	•	+	•	•	•	•
2'8 X 6'8	1-3/8"	•	•	•	•		•			•			•		•
2'8 X 6'8	1-3/4"													•	
3'0 X 6'7	1-3/4"	•	•	•	•	+	•	•	•	•	+	•	•	•	•
3'0 X 6'8	1-3/8"	•	•	•	•		•			•			•		•
3'0 X 6'8	1-3/4"													•	
1'3 X 8'0	1-3/8"														
1'4 X 8'0	1-3/8"														
1'6 X 8'0	1-3/8"	•	•	•	•		•	•			•		•		
1'8 X 8'0	1-3/8"														
2'0 X 8'0	1-3/8"	•	•	•	•		•	•			•		•		
2'4 X 8'0	1-3/8"	•	•	•	•		•	•			•		•		
2'6 X 8'0	1-3/8"	•	•	•	•		•	•			•		•		
2'8 X 7'11	1-3/4"	•	•	•	•		•	•			•	•	•		
2'8 X 8'0	1-3/8"	•	•	•	•		•	•			•	•	•		
3'0 X 7'11	1-3/4"	•	•	•	•		•	•			•	•	•		
3'0 X 8'0	1-3/8"	•	•	•	•		•	•			•	•	•		

• SMOOTH OPTION ONLY ◇ TEXTURED OPTION ONLY + BOTH OPTIONS



**1 PANEL
MADISON**



**2 PANEL ROUND TOP
SANTA FE**



**2 PANEL SQUARE
CARRARA**



**2 PANEL ROUND TOP
CAIMAN**



**2 PANEL ARCH
CAMDEN**



**2 PANEL
MONROE**



**3 PANEL
BIRKDALE**



**3 PANEL BEVELED
CRAFTSMAN**



**5 PANEL
ROCKPORT**



**6 PANEL
ROCKPORT**



**6 PANEL
COLONIST**

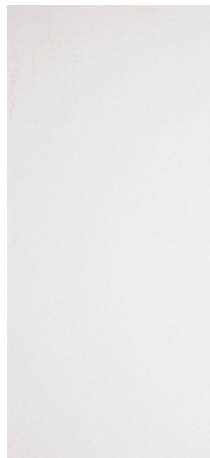

HARDBOARD



LAUAN



BIRCH

MDF SLABS



1 PANEL SHAKER
SMOOTH



2 PANEL SHAKER
SMOOTH



3 PANEL SHAKER
SMOOTH



5 PANEL SHAKER
SMOOTH



6 PANEL SHAKER
SMOOTH

SIZE	THICKNESS	1 PANEL SHAKER SMOOTH	2 PANEL SHAKER SMOOTH	3 PANEL SHAKER SMOOTH	5 PANEL SHAKER SMOOTH	6 PANEL SHAKER SMOOTH
1'0 X 6'8	1-3/8"					
1'10 X 6'8	1-3/8"					
1'2 X 6'8	1-3/8"					
1'3 X 6'8	1-3/8"					
1'4 X 6'8	1-3/8"	•	•		•	
1'6 X 6'8	1-3/8"	•	•	•	•	
1'8 X 6'8	1-3/8"	•	•		•	
2'0 X 6'8	1-3/8"	•	•	•	•	
2'4 X 6'8	1-3/8"	•	•	•	•	
2'6 X 6'8	1-3/8"	•	•	•	•	
2'8 X 6'8	1-3/4"	•	•	•	•	
2'8 X 6'8	1-3/8"	•	•	•	•	
3'0 X 6'8	1-3/4"	•	•	•	•	
3'0 X 6'8	1-3/8"	•	•	•	•	
1'3 X 8'0	1-3/8"					
1'4 X 8'0	1-3/8"	•	•			•
1'6 X 8'0	1-3/8"	•	•	•		•
1'8 X 8'0	1-3/8"					
2'0 X 8'0	1-3/8"	•	•	•		•
2'4 X 8'0	1-3/8"	•	•	•		•
2'6 X 8'0	1-3/8"	•	•	•		•
2'8 X 8'0	1-3/4"	•	•	•		•
2'8 X 8'0	1-3/8"	•	•	•		•
3'0 X 8'0	1-3/4"	•	•	•		•
3'0 X 8'0	1-3/8"	•	•	•		•



1 LITE

5 LITE

6 LITE

10 LITE

12 LITE

15 LITE

18 LITE



6 PANEL



LOUVER / LOUVER

PANTRY
FULLVIEWPANTRY
3/4 VIEW

SIZE	THICKNESS	1 LITE	5 LITE	6 LITE	10 LITE	12 LITE	15 LITE	18 LITE	6 PANEL	LVR/LVR	PANTRY FULL	PANTRY 3/4 VIEW
1'6 X 6'8	1-3/8"		•						•			
1'8 X 6'8	1-3/8"											
2'0 X 6'8	1-3/8"	•			•				•	•	•	
2'4 X 6'8	1-3/8"						•		•	•	•	
2'6 X 6'8	1-3/8"	•					•		•	•	•	
2'8 X 6'8	1-3/8"	•					•		•	•		
3'0 X 6'8	1-3/8"	•					•		•	•	•	
1'6 X 8'0	1-3/8"			•								
1'8 X 8'0	1-3/8"											
2'0 X 8'0	1-3/8"	•				•						•
2'4 X 8'0	1-3/8"					•						
2'6 X 8'0	1-3/8"	•						•				
2'8 X 8'0	1-3/8"	•						•				
3'0 X 8'0	1-3/8"	•						•				

KNOTTY PINE

INTERIORS



6 PANEL



2 PANEL ROUND TOP
V-GROOVE



2 PANEL SQUARE TOP
V-GROOVE



BARN - Z



BARN - X

SIZE	THICKNESS	6 PANEL	2 PANEL ROUND TOP V-GROOVE	2 PANEL SQUARE TOP V-GROOVE	BARN - Z	BARN - X
1'6 X 6'8	1-3/8"					
1'8 X 6'8	1-3/8"					
2'0 X 6'8	1-3/8"	•	•	•		
2'4 X 6'8	1-3/8"	•	•	•		
2'6 X 6'8	1-3/8"	•	•	•		
2'8 X 6'8	1-3/8"	•	•	•		
3'0 X 6'8	1-3/8"	•	•	•		
1'6 X 8'0	1-3/8"					
1'8 X 8'0	1-3/8"					
2'0 X 8'0	1-3/8"					
2'4 X 8'0	1-3/8"					
2'6 X 8'0	1-3/8"					
2'8 X 8'0	1-3/8"					
3'0 X 8'0	1-3/8"					
2'8 X 6'8	1-3/4"	•	•	•		
3'0 X 6'8	1-3/4"	•	•	•		
2'8 X 8'0	1-3/4"		•	•		
3'0 X 8'0	1-3/4"		•	•		
2'8 X 7'0	1-3/8"				•	•
3'0 X 7'0	1-3/8"				•	•
3'6 X 7'0	1-3/8"				•	•



**POCKET FRAME
COMPONENT**



**POCKET FRAME
COMPONENT SOLID**



**POCKET FRAME
COMPONENT INSTALLED**

SOLID WALL POCKET FRAMES AVAILABLE THRU SPECIAL ORDER		
SIZE	6'8	8'0
2'0	●	●
2'4	●	●
2'6	●	●
2'8	●	●
3'0	●	●

* SOFT CLOSING HARDWARE AVAILABLE AND SOLD SEPARATELY

* SOLID PINE FRAME FOR 2X4 WALLS

* 4-9/16" FJ FACE JAMB

ROUGH OPENINGS	
2068	50-1/2 X 83-7/8
2468	58-1/2 X 83-7/8
2668	62-1/2 X 83-7/8
2868	66-1/2 X 83-7/8
3068	74-1/2 X 83-7/8
2080	50-1/2 X 99-7/8
2480	58-1/2 X 99-7/8
2680	62-1/2 X 99-7/8
2880	66-1/2 X 99-7/8
3080	74-1/2 X 99-7/8





DOOR & MILLWORK

EXTERIOR DOORS

FIBERGLASS DOORS

OPAQUE SLABS

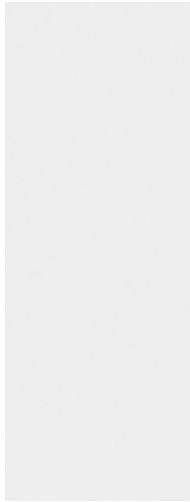

FLUSH

*SMOOTH, TEXTURED



2 PANEL SQUARE

*SMOOTH



2 PANEL CHEYENNE

*SMOOTH, TEXTURED



6 PANEL

*SMOOTH, TEXTURED

Smooth are white, ready for paint. Textured are tan oak grain, ready for finish. Mahogany grain ready for finish.

*AVAILABLE OPTIONS

MATERIAL	SIZE	FLUSH	2 PANEL SQUARE	2 PANEL CHEYENNE	6 PANEL
FIBERGLASS	2'0 X 6'8	◇			
FIBERGLASS	2'6 X 6'8	•			◇
FIBERGLASS	2'8 X 6'8	•	•	•	•
FIBERGLASS	2'10 X 6'5				
FIBERGLASS	3'0 X 6'8	•	•	•	•
FIBERGLASS SIDELITE	1'2 X 6'8				
FIBERGLASS SIDELITE	1'0 X 6'8				
FIBERGLASS	2'6 X 8'0	◇			
FIBERGLASS	2'8 X 8'0	•		•	•
FIBERGLASS	3'0 X 8'0	•	•	•	•
FIBERGLASS SIDELITE	1'0 X 8'0				

◇ TEXTURED OPTION ONLY

SEE PAGE 48 FOR SINGLE, DOUBLE, SIDELITE AND PATIO CONFIGURATIONS



Smooth are white, ready for paint. Textured are tan oak grain, ready for finish. Mahogany grain ready for finish.

*AVAILABLE OPTIONS

MATERIAL	SIZE	GLASS	FAN LITE	1 LITE SPOT LITE	2 LITE SQ SPOT LITE	4 LITE HORIZ SPOT LITE	5 LITE HORIZ SPOT LITE	HV	HV CHEYENNE	HV VENT LITE	HV VENT LITE CHEYENNE	3/4 VIEW MAHOGANY	3/4 VIEW	FULL VIEW	FULL OVAL	SL HV	SL 3/4V	SL FV
FIBERGLASS	2'0" X 6'8"	1-3/4"												◇				
FIBERGLASS	2'6" X 6'8"	1-3/4"			◇			◇						•				
FIBERGLASS	2'8" X 6'8"	1-3/4"	◇	◇	•	•	•	•	•	•	•			•	•			
FIBERGLASS	2'10" X 6'5"	1-3/4"												•				
FIBERGLASS	3'0" X 6'8"	1-3/4"	•	•	•	•	•	•	•	•	•	◇	•	•	•			
FIBERGLASS SIDELITE	1'2" X 6'8"	1-3/4"														•	•	•
FIBERGLASS SIDELITE	1'0" X 6'8"	1-3/4"														•	•	•
FIBERGLASS	2'6" X 8'0"	1-3/4"												•				
FIBERGLASS	2'8" X 8'0"	1-3/4"		•	•	•	•	•	•					•				
FIBERGLASS	3'0" X 8'0"	1-3/4"		•	•	•	•	•	•			◇	•	•				
FIBERGLASS SIDELITE	1'0" X 8'0"	1-3/4"														◇	◇	

◇ TEXTURED OPTION ONLY

SEE PAGE 48 FOR SINGLE, DOUBLE, SIDELITE AND PATIO CONFIGURATIONS

FIBERGLASS DOORS

BLINDS



**HALFVIEW
MINIBLIND**

*SMOOTH, TEXTURED

**HALFVIEW
MINIBLIND
CHEYENNE**

*SMOOTH

**3/4 VIEW
MINIBLIND**

*SMOOTH

**3/4 VIEW
MINIBLIND
MAHOGANY**

*TEXTURED

**FULLVIEW
MINIBLIND**

*SMOOTH, TEXTURED

**15 LITE
FULLVIEW
MINIBLIND**

*SMOOTH, TEXTURED

Smooth are white, ready for paint. Textured are tan oak grain, ready for finish. Mahogany grain ready for finish.

*AVAILABLE OPTIONS

MATERIAL	SIZE	GLASS	HALFVIEW MINIBLIND	HALFVIEW MINIBLIND CHEYENNE	3/4 VIEW MINIBLIND	3/4 VIEW MINIBLIND MAHOGANY	FULLVIEW MINIBLIND	15 LITE FULLVIEW MINIBLIND
FIBERGLASS	2'0 X 6'8	1-3/4"						
FIBERGLASS	2'6 X 6'8	1-3/4"					•	•
FIBERGLASS	2'8 X 6'8	1-3/4"	•	•			•	•
FIBERGLASS	2'10X6'5	1-3/4"					•	•
FIBERGLASS	3'0 X 6'8	1-3/4"	•	•	•	◇	•	•
FIBERGLASS SIDELITE	1'2 X 6'8	1-3/4"						
FIBERGLASS SIDELITE	1'0 X 6'8	1-3/4"						
FIBERGLASS	2'6 X 8'0	1-3/4"						
FIBERGLASS	2'8 X 8'0	1-3/4"	•				•	
FIBERGLASS	3'0 X 8'0	1-3/4"	•		•	◇	•	
FIBERGLASS SIDELITE	1'0 X 8'0	1-3/4"						

◇ TEXTURED OPTION ONLY

SEE PAGE 48 FOR SINGLE, DOUBLE, SIDELITE AND PATIO CONFIGURATIONS

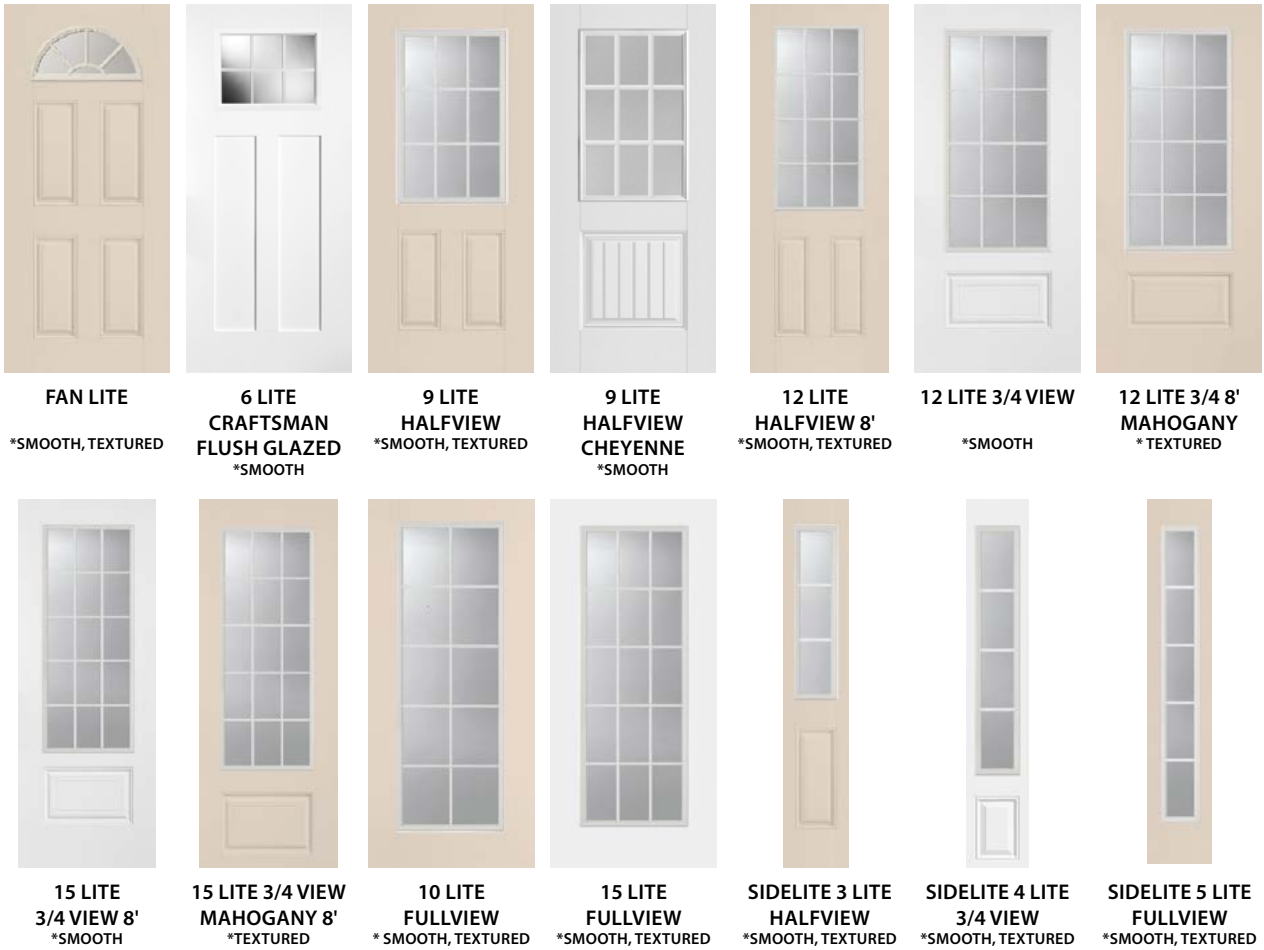

Smooth are white, ready for paint. Textured are tan oak grain, ready for finish. Mahogany grain ready for finish.

*AVAILABLE OPTIONS

MATERIAL	SIZE	GLASS	FAN LITE	6 LITE FLUSH GLAZED CRAFTSMAN	9 LITE HALF VIEW	9 LITE HV CHEYENNE	12 LITE HV 8'	12 LITE 3/4 VIEW	12 LITE 3/4 VIEW 8' MAHOGANY	15 LITE 3/4 VIEW 8'	15 LITE 3/4 VIEW MAHOGANY	10 LITE FV	15 LITE FV	SL 3 LITE HV	SL 4 LITE 3/4 V	SL 5 LITE FV
FIBERGLASS	2'0 X 6'8	1-3/4"										◇	◇			
FIBERGLASS	2'6 X 6'8	1-3/4"										•	•			
FIBERGLASS	2'8 X 6'8	1-3/4"	◇		•	•						•	•			
FIBERGLASS	2'10X6'5	1-3/4"										•	•			
FIBERGLASS	3'0 X 6'8	1-3/4"	•	•	•	•		•	•			•	•			
FIBERGLASS SIDELITE	1'2 X 6'8	1-3/4"												•	•	•
FIBERGLASS SIDELITE	1'0 X 6'8	1-3/4"												•	•	•
FIBERGLASS	2'6 X 8'0	1-3/4"														
FIBERGLASS	2'8 X 8'0	1-3/4"					•									
FIBERGLASS	3'0 X 8'0	1-3/4"		•			•			•	•					
FIBERGLASS SIDELITE	1'0 X 8'0	1-3/4"												+	±	

◇ TEXTURED OPTION ONLY

+ 1080 HV AVAILABLE IN 4LT

± 1080 3/4 V AVAILABLE IN 5LT

SEE PAGE 48 FOR SINGLE, DOUBLE, SIDELITE AND PATIO CONFIGURATIONS

FIBERGLASS DOORS

INTERNAL GRIDS



5 LITE FAN LITE
*SMOOTH, TEXTURED



9 LITE HALFVIEW
*SMOOTH



9 LITE HALFVIEW CHEYENNE
*SMOOTH



9 LITE (BRONZE) HALFVIEW
*SMOOTH, TEXTURED



9 LITE (BRONZE) HALFVIEW CHEYENNE
*SMOOTH



12 LITE HALFVIEW
*SMOOTH, TEXTURED



12 LITE 3/4 VIEW MAHOGANY
*TEXTURED



15 LITE 3/4 VIEW
*SMOOTH



15 LITE 3/4 VIEW MAHOGANY 8'
*TEXTURED

Smooth are white, ready for paint. Textured are tan oak grain, ready for finish. Mahogany grain ready for finish.

*AVAILABLE OPTIONS

MATERIAL	SIZE	GLASS	5 LITE FAN LITE	9 LITE HV	9 LITE HV CHEYENNE	9 LITE (BRONZE) HALFVIEW	9 LITE (BRONZE) HALFVIEW CHEYENNE	12 LITE HALFVIEW	12 LITE 3/4 VIEW MAHOGANY	12 LITE 3/4 VIEW	15 LITE 3/4 VIEW MAHOGANY
FIBERGLASS	2'0 X 6'8	1-3/4"									
FIBERGLASS	2'6 X 6'8	1-3/4"									
FIBERGLASS	2'8 X 6'8	1-3/4"	◇	•	•	•	•				
FIBERGLASS	2'10X6'5	1-3/4"									
FIBERGLASS	3'0 X 6'8	1-3/4"	•	•	•	•	•		◇	•	
FIBERGLASS SIDELITE	1'2 X 6'8	1-3/4"									
FIBERGLASS SIDELITE	1'0 X 6'8	1-3/4"									
FIBERGLASS	2'6 X 8'0	1-3/4"									
FIBERGLASS	2'8 X 8'0	1-3/4"						•			
FIBERGLASS	3'0 X 8'0	1-3/4"						•			◇
FIBERGLASS SIDELITE	1'0 X 8'0	1-3/4"									

SEE PAGE 48 FOR SINGLE, DOUBLE, SIDELITE AND PATIO CONFIGURATIONS

◇ TEXTURED OPTION ONLY



15 LITE (BRONZE) 3/4 VIEW MAHOGANY 8'
*TEXTURED



15 LITE 3/4 VIEW 8'
*SMOOTH



15 LITE (BRONZE) 3/4 VIEW 8'
*SMOOTH



10 LITE FULLVIEW
*SMOOTH, TEXTURED



15 LITE FULLVIEW
*SMOOTH, TEXTURED



15 LITE (BRONZE) FULLVIEW
*SMOOTH, TEXTURED



SIDELITE 3 LITE HALFVIEW
*SMOOTH, TEXTURED



SIDELITE 5 LITE FULLVIEW
*SMOOTH, TEXTURED

Smooth are white, ready for paint. Textured are tan oak grain, ready for finish. Mahogany grain ready for finish.

*AVAILABLE OPTIONS

MATERIAL	SIZE	GLASS	15 LITE (BRONZE) 3/4 VIEW MAHOGANY 8'	15 LITE 3/4 VIEW 8'	15 LITE (BRONZE) 3/4 VIEW 8'	10 LITE FULLVIEW	15 LITE FULLVIEW	15 LITE (BRONZE) FULLVIEW	SIDELITE 3 LITE HV	SIDELITE 5 LITE FV
FIBERGLASS	2'0 X 6'8	1-3/4"								
FIBERGLASS	2'6 X 6'8	1-3/4"								
FIBERGLASS	2'8 X 6'8	1-3/4"				•	•	•		
FIBERGLASS	2'10 X 6'5	1-3/4"				•	•	•		
FIBERGLASS	3'0 X 6'8	1-3/4"				•	•	•		
FIBERGLASS SIDELITE	1'2 X 6'8	1-3/4"							◇	◇
FIBERGLASS SIDELITE	1'0 X 6'8	1-3/4"							•	•
FIBERGLASS	2'6 X 8'0	1-3/4"								
FIBERGLASS	2'8 X 8'0	1-3/4"								
FIBERGLASS	3'0 X 8'0	1-3/4"	•	•	•					
FIBERGLASS SIDELITE	1'0 X 8'0	1-3/4"								

SEE PAGE 48 FOR SINGLE, DOUBLE, SIDELITE AND PATIO CONFIGURATIONS

◇ TEXTURED OPTION ONLY

FIBERGLASS DOORS

NOUVEAU



FAN LITE

*SMOOTH, TEXTURED
±NICKEL, PATINA



HALFVIEW

*SMOOTH, TEXTURED
±NICKEL, PATINA, BRASS



**HALFVIEW
CHEYENNE**

*SMOOTH
±NICKEL, PATINA, BRASS



HALFVIEW 8'

*SMOOTH, TEXTURED
±NICKEL, PATINA, BRASS



**HALFVIEW
ROUND TOP**

*SMOOTH, TEXTURED
±NICKEL, BRASS



3/4 VIEW

*SMOOTH
±NICKEL, PATINA, BRASS



**3/4 VIEW
MAHOGANY**

*TEXTURED
±NICKEL, PATINA, BRASS



**3/4 OVAL
MAHOGANY**

*TEXTURED
±NICKEL, PATINA



FULL OVAL

*SMOOTH
±BRASS

*AVAILABLE OPTIONS
± AVAILABLE FINISHES

Smooth are white, ready for paint. Textured are tan oak grain, ready for finish. Mahogany grain ready for finish.

MATERIAL	SIZE	GLASS	FAN LITE	HALF VIEW	HALFVIEW CHEYENNE	HALFVIEW ROUND TOP	3/4 VIEW	3/4 VIEW MAHOGANY	3/4 OVAL MAHOGANY	FULL OVAL
FIBERGLASS	2'0 X 6'8	1-3/4"								
FIBERGLASS	2'6 X 6'8	1-3/4"								
FIBERGLASS	2'8 X 6'8	1-3/4"	◇	•	•	◇				•
FIBERGLASS	2'10X6'5	1-3/4"								
FIBERGLASS	3'0 X 6'8	1-3/4"	•	•	•	•	•	◇	◇	•
FIBERGLASS SIDELITE	1'2 X 6'8	1-3/4"								
FIBERGLASS SIDELITE	1'0 X 6'8	1-3/4"								
FIBERGLASS	2'6 X 8'0	1-3/4"								
FIBERGLASS	2'8 X 8'0	1-3/4"		•						
FIBERGLASS	3'0 X 8'0	1-3/4"		•						
FIBERGLASS SIDELITE	1'0 X 8'0	1-3/4"								

◇ TEXTURED OPTION ONLY

+ NICKEL OPTION ONLY

SEE PAGE 48 FOR SINGLE, DOUBLE, SIDELITE AND PATIO CONFIGURATIONS



HALFVIEW
*SMOOTH, TEXTURED
±NICKEL, PATINA, IRON



HALFVIEW CHEYENNE
*SMOOTH
±NICKEL, PATINA, IRON



3/4 OVAL MAHOGANY
*TEXTURED
±NICKEL, PATINA



3/4 VIEW
*SMOOTH
±NICKEL, PATINA, IRON



3/4 VIEW MAHOGANY
*TEXTURED
±NICKEL, PATINA, IRON

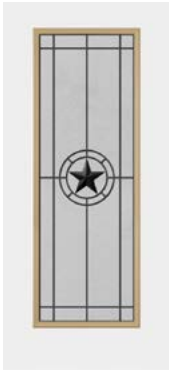

FULLVIEW
*SMOOTH, TEXTURED
±NICKEL, PATINA, IRON



SIDELITE HALFVIEW
*SMOOTH, TEXTURED
±IRON
8'0 OPTION INCLUDES PATINA



SIDELITE 3/4 VIEW
*SMOOTH, TEXTURED
±NICKEL, PATINA, IRON



SIDELITE FULLVIEW
*SMOOTH, TEXTURED
±PATINA, IRON

*AVAILABLE OPTIONS
± AVAILABLE FINISHES

Smooth are white, ready for paint. Textured are tan oak grain, ready for finish. Mahogany grain ready for finish.

MATERIAL	SIZE	GLASS	HALF VIEW	HALFVIEW CHEYENNE	3/4 OVAL MAHOGANY	3/4 VIEW	3/4 VIEW MAHOGANY	FULL VIEW	SIDELITE HALF VIEW	SIDELITE 3/4 VIEW	SIDELITE FULL VIEW
FIBERGLASS	2'0 X 6'8	1-3/4"									
FIBERGLASS	2'6 X 6'8	1-3/4"									
FIBERGLASS	2'8 X 6'8	1-3/4"	•	•				•			
FIBERGLASS	2'10X6'5	1-3/4"						•			
FIBERGLASS	3'0 X 6'8	1-3/4"	•	•	•	•	•	•			
FIBERGLASS SIDELITE	1'2 X 6'8	1-3/4"							•	•	•
FIBERGLASS SIDELITE	1'0 X 6'8	1-3/4"							•	•	•
FIBERGLASS	2'6 X 8'0	1-3/4"									
FIBERGLASS	2'8 X 8'0	1-3/4"	•								
FIBERGLASS	3'0 X 8'0	1-3/4"	•			•	◊				
FIBERGLASS SIDELITE	1'0 X 8'0	1-3/4"							•	•	

◊ TEXTURED OPTION ONLY

SEE PAGE 48 FOR SINGLE, DOUBLE, SIDELITE AND PATIO CONFIGURATIONS

FIBERGLASS DOORS

MISC



**HALFVIEW
COURTYARD 8'**
*SMOOTH, TEXTURED
±IRON



**3/4 VIEW
COURTYARD**
*SMOOTH
±IRON



**3/4 VIEW COURTYARD
MAHOGANY**
*TEXTURED
±IRON



**HALFVIEW
GRACE 8'**
*SMOOTH, TEXTURED
±NICKEL



3/4 VIEW GRACE
*SMOOTH
±NICKEL



**3/4 VIEW GRACE
MAHOGANY**
*TEXTURED
±NICKEL



**HALFVIEW
JACINTO 8'**
*SMOOTH, TEXTURED
±IRON



**3/4 VIEW
JACINTO**
*SMOOTH
±IRON



**3/4 VIEW
JACINTO MAHOGANY**
*TEXTURED
±IRON



**HALFVIEW
ELEMENT**
*SMOOTH, TEXTURED
±PATINA

Smooth are white, ready for paint. Textured are tan oak grain, ready for finish. Mahogany grain ready for finish.

MATERIAL	SIZE	GLASS	HALFVIEW COURTYARD 8'	3/4 VIEW COURTYARD MAHOGANY	3/4 VIEW COURTYARD	HALF VIEW GRACE 8'	3/4 VIEW GRACE MAHOGANY	3/4 VIEW GRACE	HALF VIEW JACINTO	3/4 VIEW JACINTO	3/4 VIEW JACINTO MAHOGANY	HALF VIEW ELEMENT
FIBERGLASS	2'0 X 6'8	1-3/4"										
FIBERGLASS	2'6 X 6'8	1-3/4"										
FIBERGLASS	2'8 X 6'8	1-3/4"										•
FIBERGLASS	2'10X6'5	1-3/4"										
FIBERGLASS	3'0 X 6'8	1-3/4"		•	•		•	•		•	•	•
FIBERGLASS SIDELITE	1'2 X 6'8	1-3/4"										
FIBERGLASS SIDELITE	1'0 X 6'8	1-3/4"										
FIBERGLASS	2'6 X 8'0	1-3/4"										
FIBERGLASS	2'8 X 8'0	1-3/4"	•			•			•			
FIBERGLASS	3'0 X 8'0	1-3/4"	•			•			•			
FIBERGLASS SIDELITE	1'0 X 8'0	1-3/4"										

SEE PAGE 48 FOR SINGLE, DOUBLE, SIDELITE AND PATIO CONFIGURATIONS



**HALFVIEW
ELEMENT CHEYENNE**
*SMOOTH
±PATINA



**HALFVIEW
GEORGIAN**
*SMOOTH, TEXTURED
±NICKEL



**HALFVIEW GEORGIAN
CHEYENNE**
*SMOOTH
±NICKEL



**HALFVIEW
MAJESTIC**
*SMOOTH, TEXTURED
±NICKEL



**HALFVIEW MAJESTIC
CHEYENNE**
*SMOOTH
±NICKEL



**FULL OVAL
HEIRLOOM**
*SMOOTH, TEXTURED
±NICKEL



**FULLVIEW
HEIRLOOM**
*SMOOTH, TEXTURED
±NICKEL



**3/4 VIEW
HEIRLOOM 8'**
*SMOOTH
±NICKEL



**3/4 VIEW HEIRLOOM
MAHOGANY 8'**
*TEXTURED
±NICKEL



**9 LITE HALFVIEW
PET DOOR°**
*SMOOTH
±NICKEL

° SEE PAGE 48
*AVAILABLE OPTIONS
± AVAILABLE FINISHES

Smooth are white, ready for paint. Textured are tan oak grain, ready for finish. Mahogany grain ready for finish.

MATERIAL	SIZE	GLASS	HALFVIEW ELEMENT CHEYENNE	HALFVIEW GEORGIAN	HALFVIEW GEORGIAN CHEYENNE	HALFVIEW MAJESTIC	HALFVIEW MAJESTIC CHEYENNE	FULL OVAL HEIRLOOM	FULLVIEW HEIRLOOM	3/4 VIEW HEIRLOOM 8'	3/4 VIEW HEIRLOOM MAHOGANY 8'	9 LITE HALFVIEW PET DOOR
FIBERGLASS	2'0 X 6'8	1-3/4"										
FIBERGLASS	2'6 X 6'8	1-3/4"										•
FIBERGLASS	2'8 X 6'8	1-3/4"	•	•	•	•	•	•	•			•
FIBERGLASS	2'10 X 6'5	1-3/4"										•
FIBERGLASS	3'0 X 6'8	1-3/4"	•	•	•	•	•	•	•			•
FIBERGLASS SIDELITE	1'2 X 6'8	1-3/4"										
FIBERGLASS SIDELITE	1'0 X 6'8	1-3/4"										
FIBERGLASS	2'6 X 8'0	1-3/4"										
FIBERGLASS	2'8 X 8'0	1-3/4"										
FIBERGLASS	3'0 X 8'0	1-3/4"								•	•	•
FIBERGLASS SIDELITE	1'0 X 8'0	1-3/4"										

SEE PAGE 48 FOR SINGLE, DOUBLE, SIDELITE AND PATIO CONFIGURATIONS

FIBERGLASS DOORS

FLUSH GLAZED (VISTA GRANDE)

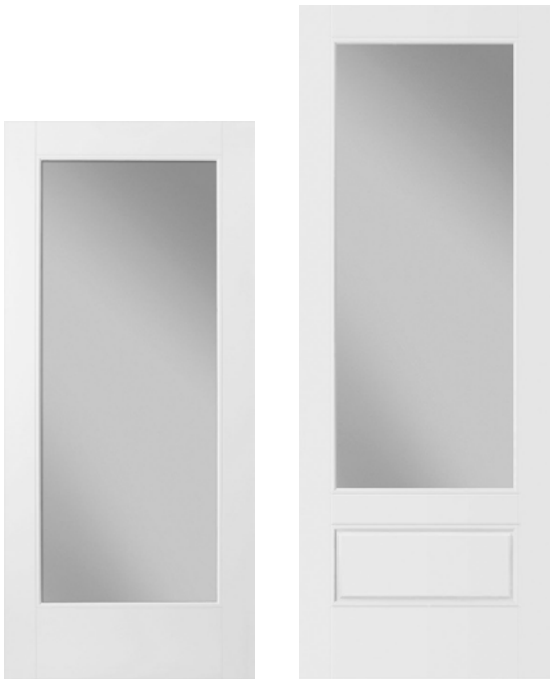

**FULL VIEW
VISTA GRANDE**

**3/4 VIEW
VISTA GRANDE**

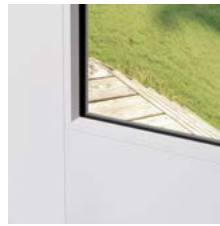

CLEAR LOW-E



**DOUBLE WATER
LOW-E**



**SDL RAILS
AVAILABLE IN
1-1/8", 3-1/2" & 5-1/2"**

MATERIAL	SIZE	GLASS	FULL VIEW	3/4 VIEW
CLEAR LOW-E	2'8 X 6'8	1-3/4"	•	
CLEAR LOW-E	3'0 X 6'8	1-3/4"	•	•
CLEAR LOW-E	2'8 X 8'0	1-3/4"	•	
CLEAR LOW-E	3'0 X 8'0	1-3/4"	•	•
DOUBLE WATER	3'0 X 6'8	1-3/4"	•	•
DOUBLE WATER	3'0 X 8'0	1-3/4"	•	•

DIVIDED LITE CONFIGURATIONS

SDL BARS 8/0

SDL BARS 6/8

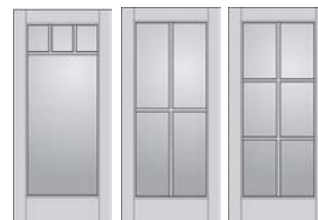

SEE PAGE 48 FOR SINGLE, DOUBLE, SIDELITE AND PATIO CONFIGURATIONS



**CRAFTSMAN
CHESTNUT
MAHOGANY**



**CRAFTSMAN
TRICORN BLACK
FLUSH GLAZED**



**3/4 VIEW
PORTOFINO CHESTNUT
MAHOGANY**



**CENTER ARCH
TURQUOISE
MEDIUM OAK**



**CENTER ARCH
TURQUOISE
WALNUT OAK**



**3/4 VIEW
LONESTAR CHESTNUT
MAHOGANY**

MATERIAL	SIZE	GLASS	CRAFTSMAN	CRAFTSMAN TRICORN BLACK FLUSH GLAZED	3/4V LONE STAR	3/4V PORTOFINO	CENTER ARCH TURQUOISE MEDIUM OAK	CENTER ARCH TURQUOISE WALNUT OAK
FIBERGLASS	3'0 X 6'8	1-3/4"	•	•	•	•	•	•

SEE PAGE 48 FOR SINGLE, DOUBLE, SIDELITE AND PATIO CONFIGURATIONS

METAL DOORS

OPAQUE SLABS



**FLUSH
NO BORE**

**2 PANEL
CAMBER PLANK**

**2 PANEL
CAMBER TOP**

**3 PANEL
CRAFTSMAN**

**4 PANEL
BLANK TOP**

6 PANEL

MATERIAL	SIZE	FLUSH NO BORE	2 PANEL CAMBER PLANK	2 PANEL CAMBER TOP	3 PANEL CRAFTSMAN	4 PANEL BLANK TOP	6 PANEL
STEEL	2'0 X 6'8	•					
STEEL	2'4 X 6'8	•					
STEEL	2'6 X 6'8	•					•
STEEL	2'8 X 6'8	•	•	•	•	•	•
STEEL	2'10 X 6'8	•					•
STEEL	2'10X6'5						
STEEL	3'0 X 6'8	•	•	•	•	•	•
STEEL	3'6 X 6'8	•					
STEEL SIDELITE	1'2 X 6'8	•					
STEEL SIDELITE	1'0 X 6'8	•					
STEEL	2'0 X 8'0	•					
STEEL	2'6 X 8'0	•					
STEEL	2'8 X 8'0	•					•
STEEL	3'0 X 8'0	•					•

SEE PAGE 48 FOR SINGLE, DOUBLE, SIDELITE AND PATIO CONFIGURATIONS



FAN LITE



1 LITE
SPOTLIGHT



2 LITE SQUARE
SPOTLIGHT

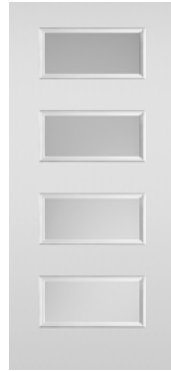

4 LITE HORIZONTAL
SPOTLIGHT



5 LITE HORIZONTAL
SPOTLIGHT



HALFVIEW



VENT LITE



3/4 VIEW



FULL VIEW



FULL OVAL



SIDELITE
HALFVIEW



SIDELITE
3/4 VIEW



SL FV
FLUSH

MATERIAL	SIZE	FAN LITE	1 LITE SPOT LIGHT	2 LITE SQUARE SPOTLIGHT	4 LITE HORIZ SPOTLIGHT	5 LITE HORIZ SPOTLIGHT	HALF VIEW	VENT LITE	3/4 VIEW	FULL VIEW	FULL OVAL	SIDELITE HV	SIDELITE 3/4 VIEW	SIDELITE FV
STEEL	2'0 X 6'8									•				
STEEL	2'4 X 6'8									•				
STEEL	2'6 X 6'8		•	•						•				
STEEL	2'8 X 6'8	•	•	•	•	•	•	•	•	•	•			
STEEL	2'10 X 6'8		•	•	•	•				•	•			
STEEL	2'10X6'5									•				
STEEL	3'0 X 6'8	•	•	•	•	•	•	•	•	•	•			
STEEL	3'6 X 6'8									•	•			
STEEL SIDELITE	1'2 X 6'8											•	•	•
STEEL SIDELITE	1'0 X 6'8											•	•	•
STEEL	2'0 X 8'0									•				
STEEL	2'6 X 8'0									•				
STEEL	2'8 X 8'0			•	•	•	•			•				
STEEL	3'0 X 8'0			•	•	•	•			•				

SEE PAGE 48 FOR SINGLE, DOUBLE, SIDELITE AND PATIO CONFIGURATIONS

METAL DOORS

BLINDS



**HALFVIEW
MINIBLIND**



**3/4 VIEW
MINIBLIND**



**FULLVIEW
MINIBLIND**



**15 LITE
FULLVIEW
MINIBLIND**



**HALFVIEW
MINIBLIND
WITH PET DOOR[°]**

[°] SEE PAGE 48

MATERIAL	SIZE	GLASS	HALFVIEW MINIBLIND	3/4 VIEW MINIBLIND	FULLVIEW MINIBLIND	15 LITE FULLVIEW MINIBLIND	HALFVIEW MINIBLIND WITH PET DOOR
STEEL	2'0 X 6'8	1-3/4"					
STEEL	2'4 X 6'8	1-3/4"					
STEEL	2'6 X 6'8	1-3/4"			•		
STEEL	2'8 X 6'8	1-3/4"	•	•	•	•	•
STEEL	2'10 X 6'8	1-3/4"	•		•	•	•
STEEL	2'10 X 6'5	1-3/4"			•	•	
STEEL	3'0 X 6'8	1-3/4"	•	•	•	•	•
STEEL	3'6 X 6'8	1-3/4"	•		•		
STEEL SIDELITE	1'2 X 6'8	1-3/4"					
STEEL SIDELITE	1'0 X 6'8	1-3/4"					
STEEL	2'0 X 8'0	1-3/4"					
STEEL	2'6 X 8'0	1-3/4"					
STEEL	2'8 X 8'0	1-3/4"	•		•		•
STEEL	3'0 X 8'0	1-3/4"	•		•		•

SEE PAGE 48 FOR SINGLE, DOUBLE, SIDELITE AND PATIO CONFIGURATIONS



FAN LITE 6 LITE CRAFTSMAN 9 LITE HALFVIEW 12 LITE 3/4 VIEW 10 LITE FULLVIEW



15 LITE FULLVIEW SIDELITE 3 LITE HALFVIEW SIDELITE 4 LITE 3/4 VIEW SIDELITE 5 LITE FULLVIEW

MATERIAL	SIZE	GLASS	FAN LITE	6 LITE CRAFTSMAN	9 LITE HALFVIEW	12 LITE 3/4 VIEW	10 LITE FULLVIEW	15 LITE FULLVIEW	SIDELITE 3 LITE HALFVIEW	SIDELITE 4 LITE 3/4 VIEW	SIDELITE 5 LITE FULLVIEW
STEEL	2'0 X 6'8	1-3/4"					•				
STEEL	2'4 X 6'8	1-3/4"					•				
STEEL	2'6 X 6'8	1-3/4"			•		•				
STEEL	2'8 X 6'8	1-3/4"	•	•	•		•	•			
STEEL	2'10 X 6'8	1-3/4"			•		•	•			
STEEL	2'10 X 6'5	1-3/4"					•	•			
STEEL	3'0 X 6'8	1-3/4"	•	•	•	•	•	•			
STEEL	3'6 X 6'8	1-3/4"			•	•					
STEEL SIDELITE	1'2 X 6'8	1-3/4"							•	•	•
STEEL SIDELITE	1'0 X 6'8	1-3/4"							•	•	•
STEEL	2'0 X 8'0	1-3/4"									
STEEL	2'6 X 8'0	1-3/4"									
STEEL	2'8 X 8'0	1-3/4"			◇						
STEEL	3'0 X 8'0	1-3/4"			◇						

SEE PAGE 48 FOR SINGLE, DOUBLE, SIDELITE AND PATIO CONFIGURATIONS

◇ 8'0 HALFVIEW IS A 12 LITE

METAL DOORS

INTERNAL GRIDS



5 LITE
FAN LITE



9 LITE
HALFVIEW

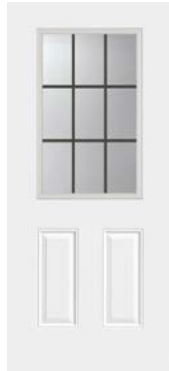

9 LITE (BRONZE)
HALFVIEW

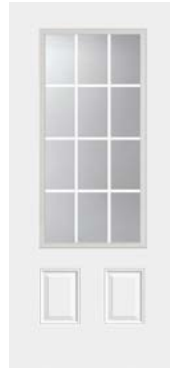

12 LITE
3/4 VIEW



12 LITE
HALFVIEW



10 LITE
FULLVIEW



15 LITE
FULLVIEW



15 LITE (BRONZE)
FULLVIEW



SIDELITE 3 LITE
HALFVIEW



SIDELITE 5 LITE
FULLVIEW

MATERIAL	SIZE	GLASS	5 LITE FAN LITE	9 LITE HALF VIEW	9 LITE (BRONZE) HALFVIEW	12 LITE 3/4 VIEW	12 LITE HALFVIEW	10 LITE FULL VIEW	15 LITE FULL VIEW	15 LITE (BRONZE) FULLVIEW	SIDELITE 3 LITE HALFVIEW	SIDELITE 5 LITE FULLVIEW
STEEL	2'0 X 6'8	1-3/4"						•				
STEEL	2'4 X 6'8	1-3/4"						•				
STEEL	2'6 X 6'8	1-3/4"		•	•			•				
STEEL	2'8 X 6'8	1-3/4"	•	•	•			•	•	•		
STEEL	2'10 X 6'8	1-3/4"		•	•			•	•	•		
STEEL	2'10X6'5	1-3/4"						•	•	•		
STEEL	3'0 X 6'8	1-3/4"	•	•	•	•		•	•	•		
STEEL	3'6 X 6'8	1-3/4"										
STEEL SIDELITE	1'2 X 6'8	1-3/4"									•	•
STEEL SIDELITE	1'0 X 6'8	1-3/4"									•	•
STEEL	2'0 X 8'0	1-3/4"										
STEEL	2'6 X 8'0	1-3/4"										
STEEL	2'8 X 8'0	1-3/4"					•					
STEEL	3'0 X 8'0	1-3/4"					•					

SEE PAGE 48 FOR SINGLE, DOUBLE, SIDELITE AND PATIO CONFIGURATIONS



FAN LITE
*NICKEL, PATINA



HALFVIEW
*NICKEL, PATINA,
BRASS

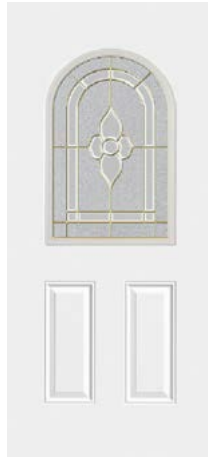

**HALFVIEW
ROUND TOP**
*NICKEL, PATINA,
BRASS



3/4 VIEW
*NICKEL, PATINA,
BRASS



3/4 OVAL
*NICKEL, PATINA



FULL OVAL
*BRASS

*AVAILABLE FINISHES

MATERIAL	SIZE	GLASS	FAN LITE	HALFVIEW	HALFVIEW ROUND TOP	3/4 VIEW	3/4 OVAL	FULL OVAL
STEEL	2'8 X 6'8	1-3/4"	•	•	•	•	•	•
STEEL	2'10 X 6'8	1-3/4"		•				•
STEEL	3'0 X 6'8	1-3/4"	•	•	•	•	•	•
STEEL	3'6 X 6'8	1-3/4"						
STEEL SIDELITE	1'2 X 6'8	1-3/4"						
STEEL SIDELITE	1'0 X 6'8	1-3/4"						
STEEL	2'8 X 8'0	1-3/4"		•				
STEEL	3'0 X 8'0	1-3/4"		•				

SEE PAGE 48 FOR SINGLE, DOUBLE, SIDELITE AND PATIO CONFIGURATIONS

METAL DOORS

TEXAS STAR



3/4 OVAL

*NICKEL, PATINA



HALFVIEW

*NICKEL, PATINA,
IRON



3/4 VIEW

*NICKEL, PATINA,
IRON



FULLVIEW

*NICKEL, PATINA,
IRON



**SIDELITE
HALFVIEW**
*IRON



**SIDELITE
3/4 VIEW**
*NICKEL, PATINA,
IRON



**SIDELITE
FULLVIEW**
*PATINA, IRON

*AVAILABLE FINISHES

MATERIAL	SIZE	GLASS	3/4 OVAL	HALFVIEW	3/4 VIEW	FULLVIEW	SIDELITE HALFVIEW	SIDELITE 3/4 VIEW	SIDELITE FULLVIEW
STEEL	2'8 X 6'8	1-3/4"	•	•	•	•			
STEEL	2'10 X 6'8	1-3/4"		•					
STEEL	3'0 X 6'8	1-3/4"	•	•	•	•			
STEEL	3'6 X 6'8	1-3/4"							
STEEL SIDELITE	1'2 X 6'8	1-3/4"					•	•	•
STEEL SIDELITE	1'0 X 6'8	1-3/4"					•	•	•
STEEL	2'8 X 8'0	1-3/4"		•					
STEEL	3'0 X 8'0	1-3/4"		•					

SEE PAGE 48 FOR SINGLE, DOUBLE, SIDELITE AND PATIO CONFIGURATIONS



**3/4 VIEW
COURTYARD**

*IRON



**3/4 VIEW
GRACE**

*NICKEL



**3/4 VIEW
JACINTO**

*IRON



**HALFVIEW
ELEMENT**

*PATINA



**9 LITE
HALFVIEW PET
DOOR^o**

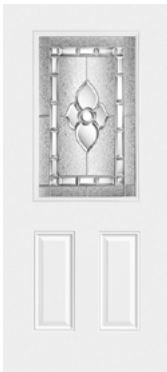

**HALFVIEW
GEORGIAN**

*IRON

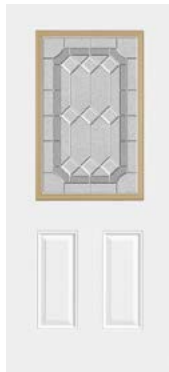

**HALFVIEW
MAJESTIC**

*NICKEL



**FULLVIEW OVAL
HEIRLOOM**

*NICKEL



**FULLVIEW
HEIRLOOM**

*NICKEL

^o SEE PAGE 48
*AVAILABLE FINISHES

MATERIAL	SIZE	GLASS	3/4 VIEW COURTYARD	3/4 VIEW GRACE	3/4 VIEW JACINTO	HALFVIEW ELEMENT	HALFVIEW GEORGIAN	HALFVIEW MAJESTIC	FULLVIEW OVAL HEIRLOOM	FULLVIEW HEIRLOOM	9 LITE HALFVIEW PET DOOR
STEEL	2'8 X 6'8	1-3/4"	•	•	•	•	•	•	•	•	•
STEEL	2'10 X 6'8	1-3/4"							•	•	•
STEEL	3'0 X 6'8	1-3/4"	•	•	•	•	•	•	•	•	•
STEEL	3'6 X 6'8	1-3/4"								•	•
STEEL SIDELITE	1'2 X 6'8	1-3/4"									
STEEL SIDELITE	1'0 X 6'8	1-3/4"									
STEEL	2'8 X 8'0	1-3/4"									•
STEEL	3'0 X 8'0	1-3/4"									•

SEE PAGE 48 FOR SINGLE, DOUBLE, SIDELITE AND PATIO CONFIGURATIONS

WOOD DOORS

MAHOGANY/KNOTTY ALDER



**2 PANEL ARCH TOP
V-GROOVE (INTERIOR)**

*KNOTTY ALDER ONLY



**6 LITE LOW E
CRAFTSMAN**

*MAHOGANY, KNOTTY ALDER



**4 LITE LOW E
3/4 VIEW**

*MAHOGANY ONLY
+ BEVELED OR DOUBLE
WATER GLASS OPTION



**4 LITE LOW E
3/4 VIEW 8'**

*MAHOGANY ONLY
+ BEVELED OR DOUBLE
WATER GLASS OPTION



**6 LITE LOW E
3/4 VIEW**

*MAHOGANY ONLY
+ BEVELED OR DOUBLE
WATER GLASS OPTION



**6 LITE LOW E
3/4 VIEW 8'**

*MAHOGANY ONLY
+ BEVELED OR DOUBLE
WATER GLASS OPTION



MAHOGANY 615.8'0

*MAHOGANY, KNOTTY ALDER



MAHOGANY 623.8'0

*MAHOGANY, KNOTTY ALDER



MAHOGANY 837.8'0

*MAHOGANY, KNOTTY ALDER



MAHOGANY 616.8'0

*MAHOGANY, KNOTTY ALDER

**GLASS OPTION FOR THE 4 OR 6 LITE
LOW E 3/4 VIEW DOORS**



*DOUBLE WATER

TYPE	SIZE	THICKNESS	2 PANEL ARCH TOP V-GROOVE	6 LITE LOW E CRAFTSMAN	4 LITE LOW E 3/4 VIEW	6 LITE LOW E 3/4 VIEW	MAHOGANY 615.8'0	MAHOGANY 623.8'0	MAHOGANY 837.8'0	MAHOGANY 616.8'0
INT	1'6 X 6'8	1-3/8"	•							
INT	1'8 X 6'8	1-3/8"	•							
INT	2'0 X 6'8	1-3/8"	•							
INT	2'4 X 6'8	1-3/8"	•							
INT	2'6 X 6'8	1-3/8"	•							
INT	2'8 X 6'8	1-3/8"	•							
INT	3'0 X 6'8	1-3/8"	•							
INT	1'6 X 8'0	1-3/8"	•							
INT	1'8 X 8'0	1-3/8"								
INT	2'0 X 8'0	1-3/8"	•							
INT	2'4 X 8'0	1-3/8"	•							
INT	2'6 X 8'0	1-3/8"	•							
INT	2'8 X 8'0	1-3/8"	•							
INT	3'0 X 8'0	1-3/8"	•							
EXT	3'0 X 6'8	1-3/4"	•	•	•	•	•	•	•	•
EXT	3'0 X 8'0	1-3/4"	•	•	•	•	•	•	•	•

SEE PAGE 48 FOR SINGLE, DOUBLE, SIDELITE AND PATIO CONFIGURATIONS



MAHOGANY 615.6'8

*MAHOGANY, KNOTTY ALDER



MAHOGANY 623.6'8

*MAHOGANY, KNOTTY ALDER



MAHOGANY 837.6'8

*MAHOGANY, KNOTTY ALDER



MAHOGANY 616.6'8

*MAHOGANY, KNOTTY ALDER

GLASS OPTIONS FOR IRON GRILLE DOORS



AQUATEX



COTSWOLD



FLEMISH



REEDED



MAHOGANY 84.8'0

*MAHOGANY, KNOTTY ALDER



MAHOGANY 3055.8'0

*MAHOGANY, KNOTTY ALDER



KNOTTY ALDER 84.6'8

*MAHOGANY, KNOTTY ALDER



KNOTTY ALDER 3055.6'8

*MAHOGANY, KNOTTY ALDER

TYPE	SIZE	THICKNESS	MAHOGANY 615.6'8	MAHOGANY 623.6'8	MAHOGANY 837.6'8	MAHOGANY 616.6'8	MAHOGANY 84.8'0	MAHOGANY 3055.8'0	KNOTTY ALDER 84.6'8	KNOTTY ALDER 3055.6'8
EXT	3'0 X 6'8	1-3/4"	•	•	•	•	•	•	•	•
EXT	3'0 X 8'0	1-3/4"	•	•	•	•	•	•	•	•

SEE PAGE 48 FOR SINGLE, DOUBLE, SIDELITE AND PATIO CONFIGURATIONS





DOOR & MILLWORK

DOOR COMPONENTS

DOOR COMPONENTS

DOOR HINGE OPTIONS / VENTS



RESIDENTIAL DOOR HINGE COLOR OPTIONS

- * STEEL BASE MATERIAL
- * 5/8 RADIUS CORNERS
- * PLAIN BEARING, FIVE KNUCKLE

- * NON-RISING REMOVABLE CAP-STYLE PIN
- * AVAILABLE IN 3.5" & 4.0"



ZINC 2D



SATIN NICKEL



RUBBED BRONZE



BLACK 1D



BRUSHED CHROME



ANTIQUÉ BRASS



ANTIQUÉ NICKEL



STAINLESS STEEL



BRIGHT BRASS



POLISHED CHROME

V-SLAT VENTS

ACCOMODATES 1-3/8" AND 1-3/4" DOORS



VENT KNOTTY ALDER
12X12X1-3/8 V-SLAT
12X12X1-3/4 V-SLAT
12X16X1-3/8 V-SLAT
12X16X1-3/4 V-SLAT

VENT KNOTTY ALDER
20X24X1-3/8 V-SLAT
20X24X1-3/4 V-SLAT

ALDER FRAME
12X12X1-3/8 1LT SG
12X12X1-3/4 1LT SG

INTERIOR JAMBS

INTERIOR JAMBS	SIZE	WIDTH	THICKNESS	PRIMED FJ PINE	STAIN GRADE	KNOTTY ALDER
81" BELOW DADO	6'8	4-5/8"	11/16"	•	•	
97" BELOW DADO	8'0	4-5/8"	11/16"	•	•	
81" BELOW DADO	6'8	4-7/8"	11/16"	•		
97" BELOW DADO	8'0	4-7/8"	11/16"	•		
81" BELOW DADO	6'8	6-5/8"	11/16"	•	•	
97" BELOW DADO	8'0	6-5/8"	11/16"	•	•	
81" BELOW DADO	6'8	4-5/8"	3/4"			•
97" BELOW DADO	8'0	4-5/8"	3/4"			•
81" BELOW DADO	6'8	6-5/8"	3/4"			•
97" BELOW DADO	8'0	6-5/8"	3/4"			•

- * SOFT EDGES ON FACE OF JAMBS WITH TRIM GUIDE
- * AVAILABLE WITH KERF STOP UPON REQUEST
- * OPEN FRAMES AVAILABLE IN ALL SPECIES OF JAMBS
- * SHEET ROCK RETURN FRAMES AVAILABLE UPON REQUEST



PRIMED FJ PINE



STAIN GRADE



KNOTTY ALDER

EXTERIOR JAMBS

SIZE	WIDTH	THICKNESS	NO ROT PRIMED FJ	MAHOGANY KERF	KNOTTY ALDER KERF	COMPOSITE JAMB
6'8	4-9/16"	1-7/32"	•	•	•	•
8'0	4-9/16"	1-7/32"	•	•	•	•
6'8	6-9/16"	1-7/32"	•	•	•	•
8'0	6-9/16"	1-7/32"	•	•	•	•
6'8	5-1/8"	1-7/32"	•			
8'0	5-1/8"	1-7/32"	•			
6'8	5-3/8"	1-7/32"	•			
8'0	5-3/8"	1-7/32"	•			
6'8	9-1/16"	1-7/32"	•			
8'0	9-1/16"	1-7/32"	•			

- * EXTENDERS AVAILABLE TO MAKE JAMBS SIZE NEEDED
- * EXTERIOR JAMB COMPONENTS AVAILABLE IN ALL SPECIES
- * DOUBLE RABBIT FRAMES AVAILABLE UPON REQUEST



NO ROT PRIMED



MAHOGANY STAIN GRADE



KNOTTY ALDER

DOOR COMPONENTS

SILLS

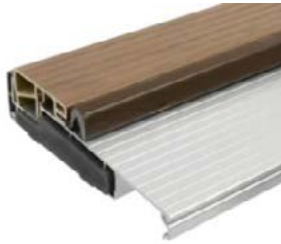

OPEN OUT SILLS

SIZE		WIDTH	TYPE	MILL FINISH	BRONZE FINISH
24"	2'0"	4-9/16"	BUMPER OO	•	•
30"	2'6"	4-9/16"	BUMPER OO	•	•
32"	2'8"	4-9/16"	BUMPER OO	•	•
34"	2'10"	4-9/16"	BUMPER OO	•	•
36"	3'0"	4-9/16"	BUMPER OO	•	•
60"	5'0"	4-9/16"	BUMPER OO	•	•
64"	5'4"	4-9/16"	BUMPER OO	•	•
74"	PATIO	4-9/16"	BUMPER OO		•
108"	9'0"	4-9/16"	BUMPER OO	•	•
148"	12.3'	4-9/16"	BUMPER OO	•	•



OPEN IN SILLS

SIZE		WIDTH	TYPE	MILL FINISH	BRONZE FINISH
24"	2'0"	4-9/16"	ADJ OI	•	•
30"	2'6"	4-9/16"	ADJ OI	•	•
32"	2'8"	4-9/16"	ADJ OI	•	•
34"	2'10"	4-9/16"	ADJ OI	•	•
36"	3'0"	4-9/16"	ADJ OI	•	•
60"	5'0"	4-9/16"	ADJ OI		•
64"	5'4"	4-9/16"	ADJ OI		•
72.5"	DOUBLE	4-9/16"	ADJ OI	•	•
74"	PATIO	4-9/16"	ADJ OI	•	•
67.5"	SIDELITE	4-9/16"	ADJ OI	•	•
148"	12.3'	4-9/16"	ADJ OI	•	•
32"	2'8"	5-5/8"	ADJ OI	•	•
36"	3'0"	5-5/8"	ADJ OI	•	•
72.5"	DOUBLE	5-5/8"	ADJ OI	•	•
74"	PATIO	5-5/8"	ADJ OI	•	•
67.5"	SIDELITE	5-5/8"	ADJ OI	•	•
148"	12.3'	5-5/8"	ADJ OI	•	•



ADA SILLS

SIZE		WIDTH	TYPE	MILL FINISH	BRONZE FINISH
24"	2'0"	4-9/16"	ADJ OI	•	•
30"	2'6"	4-9/16"	ADJ OI	•	•
32"	2'8"	4-9/16"	ADJ OI	•	•
34"	2'10"	4-9/16"	ADJ OI	•	•
36"	3'0"	4-9/16"	ADJ OI	•	•

REPLACEABLE DECK SILLS

SIZE	WIDTH	TYPE	MILL FINISH	BRONZE FINISH
2'8"	4-9/16"	OI	•	•
3'0"	4-9/16"	OI	•	•
6'0"	4-9/16"	OI	•	•
2'8"	6-9/16"	OI	•	•
3'0"	6-9/16"	OI	•	•
6'0"	6-9/16"	OI	•	•



REPLACEABLE DECK SILLS

REPLACEABLE DECK

SIZE	WIDTH	TYPE	MILL FINISH	BRONZE FINISH
2'8"	4-9/16"		•	•
6'0"	4-9/16"		•	•
3'0"	6-9/16"		•	•
6'0"	6-9/16"		•	•



WEATHERSTRIP

WEATHERSTRIP

SIZE	WEATHERSTRIP	BEIGE	BRONZE
81"	JF65	•	•
97"	JF65	•	•
97"	LONG REACH	•	•



SWEEPS

SWEEPS

SIZE	SWEEPS	BEIGE	BRONZE
31-3/4"	FBG/MTL	•	
35-3/4"	FBG/MTL	•	
41-3/4"	FBG/MTL	•	
35-3/4"	WOOD	•	•
42"	WOOD		•
48"	WOOD	•	•

* SILL EXTENDERS AVAILABLE IN:
3/4", 2" & 2" FOR OO & OI ONLY

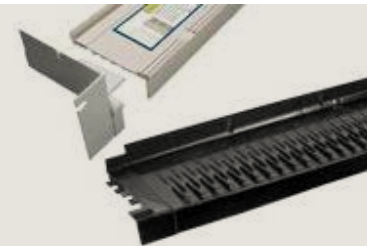

SILL PANS

AVAILABLE UP TO:
4-9/16" UP TO 78"
6-9/16" UP TO 78"

DOOR COMPONENTS

PANOLOCK MULTI-POINT LOCK

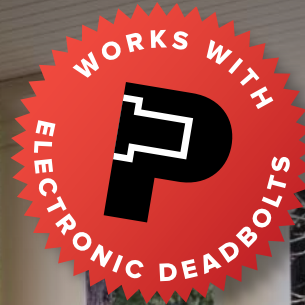

PANOLOCK+
MULTI-POINT LOCK

PanoLock®+ is the first and only multi-point lock that works with a wide variety of off-the-shelf hardware, including electronic deadbolts! That's affordable security and performance for every entry door.

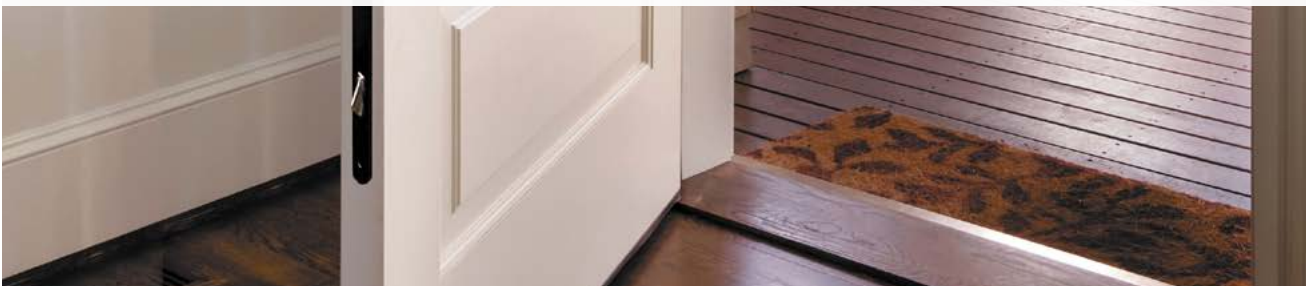



DOOR COMPONENTS

PANOLOCK MULTI-POINT LOCK

Works with a wide variety of standard hardware, including electronic deadbolts.*

Use of multi-point locks has been limited due to high cost, difficult installation and operation, and the limitations of dedicated handleset hardware required for each lock offering. Not so with PanoLock®+.

An innovative system of adapters lets PanoLock+ work with a wide variety of off-the-shelf hardware. Both standard and smart locks. Brands like Schlage, Kwikset and more.

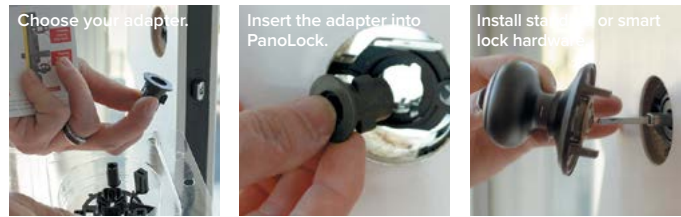

PanoLock+ Square Adapter.

PanoLock+ can work with a thumb press, lever or knob.

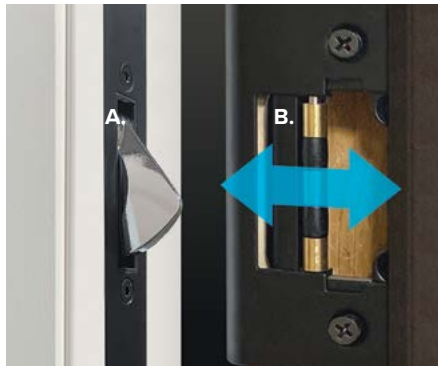

A. Tapered bolt. Unlike other locks that tend to catch, PanoLock+'s tapered bolts engage easily, even when the door is out of alignment.

B. Adjustable roller strike. Rollers lower operating force allowing the tapered bolt to gently snug the door panel against the weatherstrip.

Faceplate Finishes



Bronze Anodized Satin Nickel



White Anodized

Sizes
6/8
8/0

Adjustable Strike Plate Finishes



Victorian Bronze Satin Nickel Bright Brass



Black Stainless Steel

Security. Performance. Standard.

Easy to live with.

A simple turn of the deadbolt operates both tapered bolts smoothly and the handle-set operates the handle-set latch. Three points of secure contact. PanoLock+ is easy to live with, even after years of use.

Easy to work with.

PanoLock+ is flexible. Hanging and swing can be set in the shop, reducing SKUs.

- No dedicated hardware required.
- No need for dedicated panels.
- No difficult installation.
- No expensive templates.

Tested and proven.

PanoLock+ has been extensively tested and proven to perform, even in severe conditions. PanoLock+ withstood winds up to 200 mph in structural testing.

- Operating torque/force tested as low as 2 in/lbs with select handle sets.
- Durability Cycle Testing Passed 100,000 cycles.
- Air Infiltration and Exfiltration Tested to A2.
- Water Infiltration and Exfiltration Tested DP60 with Z-Articulating Cap sill.
- Impact/Forced Entry Resistance Tested Grade 40.



*Please refer to Endura's website to verify that your lockset choice has been tested for compatibility with PanoLock+.

<https://www.enduraproducts.com/pano-lock-plus/>

Innovation powered by Endura.
Innovation protected under patents and patents pending in U.S. and Canada.
See www.endurapatents.com.
Form # RDS SS-23 Effective 3/10/23 © Endura Products



LIGHTEN

IN-FRAME LIGHT



NEW!

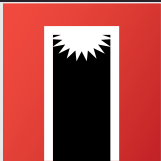

LIGHTEN™ IN-FRAME LIGHT

Built with security in mind, a battery powered light bar built into the jamb header illuminates entry doors when movement is detected using dusk-to-dawn motion sensors. Add functionality and peace of mind to any exterior door with LightEn™.



Introducing LightEn™, an innovative lighted header addition to Endura's outstanding line of door frames for pre-hung exterior doors. LightEn equips entry doors with a built-in overhead light to provide illumination at night for security and convenience.



Features and Benefits

Requires No Wiring:

The LightEn header is battery-powered and removes the need for in-home wiring.

Automatic Light:

Dusk to dawn automatic motion sensors ensure illumination at night and in dark areas.

Battery Pack:

LightEn is powered with Lithium AA batteries. The battery pack uses eight standard Lithium AA batteries for easy off-the-shelf replacement.

Availability and Pricing

- Compatible with Endura FusionFrame, FrameSaver and commodity jams.
- Length Options:
Single Doors (2/6 to 3/0)
Double Doors (up to 6/0)
Mull Headers (1/2-3/0-1/2)



INNOVATION POWERED BY ENDURA.

Endura is built on innovation and a commitment to performance. Our products are problem solvers, born directly from insight we've learned from our customers about real-world challenges. We're always pushing ourselves to face an ever-present challenge: How can we make your door system work better?

Innovation protected under patents and patents pending in U.S. and Canada.
See www.endurapatents.com.
Form #LightEn Pre Effective 10/2/24 © Endura Products



DOOR COMPONENTS

WOOD DOOR ACCESSORIES / PET DOOR



WOOD DOOR ACCESSORIES



FLORENTINE GRILLE
BLACK



MADRID GRILLE
BLACK



PARIS KW GRILLE BLACK



28" FLORENTINE STRAP



28" MADRID STRAP



SPEAKEASY DOOR



1.5" ROUND
CLAVO



1.5" SQUARE
CLAVO



PET DOOR COMPONENT

AVAILABLE IN 4 SIZES
SMALL PET DOOR WHT
MEDIUM PET DOOR WHT
EXTRA-LRG PET DOOR WHT
SUPER-LRG PET DOOR WHT

PET DOORS CAN BE INSTALLED ONTO ANY FLUSH BOTTOM DOOR.



DOOR & MILLWORK

DOOR INFORMATION

EXTERIOR DOOR UNIT SIZES & ROUGH OPENINGS

Inswing				Outswing			
		Minimum				Minimum	
Call Size	Actual Size	Rough Opening	Call Size	Actual Size	Rough Opening	Call Size	Rough Opening
Single							
2/0 6/8	25- 1/2 x 81-3/4	26-1/2 x 82-1/2	2/0 6/8	25- 1/2 x 80-3/8	26-1/2 x 81-1/8		
2/4 6/8	29-1/2 x 81-3/4	30-1/2 x 82-1/2	2/4 6/8	29- 1/2 x 80-3/8	30- 1/2 x 81-1/8		
2/6 6/8	31-1/2 x 81-3/4	32-1/2 x 82-1/2	2/6 6/8	31- 1/2 x 80-3/8	32-1/2 x 81-1/8		
2/8 6/8	33-1/2 x 81-3/4	34-1/2 x 82-1/2	2/8 6/8	33-1/2 x 80-3/8	34- 1/2 x 81-1/8		
3/0 6/8	37-1/2 x 81-3/4	38-1/2 x 82-1/2	3/0 6/8	37- 1/2 x 80-3/8	38- 1/2 x 81-1/8		
Double							
4/0 6/8	50 x 81-3/4	51 x 82-1/2	4/0 6/8	49-7/8 x 80-3/8	50-7/8 x 81-1/8		
5/0 6/8	62 x 81-3/4	63 x 82-1/2	5/0 6/8	61-7/8 x 80-3/8	62-7/8 x 81-1/8		
5/4 6/8	66 x 81-3/4	67 x 82-1/2	5/4 6/8	65-7/8 x 80-3/8	66-7/8 x 81-1/8		
6/0 6/8	74 x 81-3/4	75 x 82-1/2	6/0 6/8	73-7/8 x 80-3/8	74-7/8 x 81-1/8		
Patio							
4/0 6/8	50-1/4 x 81-3/4	51-1/4 x 82-1/2	4/0 6/8	50-1/4 x 80-3/8	51-1/4 x 81-1/8		
5/0 6/8	62-1/4 x 81-3/4	63-1/4 x 82-1/2	5/0 6/8	62-1/4 x 80-3/8	63-1/4 x 81-1/8		
5/4 6/8	66-1/4 x 81-3/4	67-1/4 x 82-1/2	5/4 6/8	66-1/4 x 80-3/8	67-1/4 x 81-1/8		
6/0 6/8	74-1/4 x 81-3/4	75-1/4 x 82-1/2	6/0 6/8	74-1/4 x 80-3/8	75-1/4 x 81-1/8		
TDI Patio							
4/0 6/8	50-3/4 x 81-3/4	51-3/4 x 82-1/2	4/0 6/8	50-3/4 x 80-3/8	51-3/4 x 81-1/8		
5/0 6/8	62-3/4 x 81-3/4	63-3/4 x 82-1/2	5/0 6/8	62-3/4 x 80-3/8	63-3/4 x 81-1/8		
5/4 6/8	66-3/4 x 81-3/4	67-3/4 x 82-1/2	5/4 6/8	66-3/4 x 80-3/8	67-3/4 x 81-1/8		
6/0 6/8	74-3/4 x 81-3/4	75-3/4 x 82-1/2	6/0 6/8	74-3/4 x 80-3/8	75-3/4 x 81-1/8		
Retro							
5/0 6/8	59-1/2 x 79-3/4	60x80	5/0 6/8	59-1/2 x 78-3/8	60 x 80		
6/0 6/8	71-1/2 x 79-3/4	72 x 80	6/0 6/8	71-1/2 x 78-3/8	72 x 80		

For 8/0 tall units, add 16" to Heights

DOOR HANDING GUIDE































INSWING



INSWING



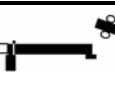









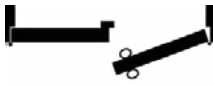

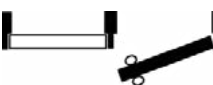

X = Operating door O = Fixed door





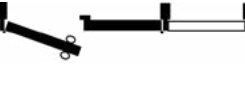

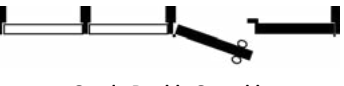

Point of Reference = Standing on the Exterior side of Unit

 Single X - Left Hand	Interior  Exterior Single X - Right Hand	 Quad - Double Operable OOX - Left Hand	 Quad - Double Operable OOX - Right Hand
 Double XX - Left Hand	 Double XX - Right Hand	 Quad - Center Double Operable OXXO - Left Hand	 Quad - Center Double Operable OXXO - Right Hand
 Patio - Center Hinge OX - Left Hand	 Patio - Center Hinge XO - Right Hand	 Quad - Double Operable XXOO - Left Hand	 Quad - Double Operable XXOO - Right Hand
 Patio - Jamb Hinge XO - Left Hand	 Patio - Jamb Hinge OX - Right Hand	 Quad - Single Operable OOOX - Left Hand	 Quad - Single Operable OOOX - Right Hand
 Triple Unit - Center Operable OXO - Left Hand	 Triple Unit - Center Operable OXO - Right Hand	 Quad - Single Operable OOXO - Left Hand	 Quad - Single Operable OOXO - Right Hand
 Triple Unit - Single Operable OOX - Left Hand	 Triple Unit - Single Operable XOO - Right Hand	 Quad - Single Operable OXOO - Left Hand	 Quad - Single Operable OXOO - Right Hand
 Triple Unit - Single Operable XOO - Left Hand	 Triple Unit - Single Operable OOX - Right Hand	 Quad - Single Operable XOOO - Left Hand	 Quad - Single Operable XOOO - Right Hand
 Triple Unit - Double Operable XXO - Left Hand	 Triple Unit - Double Operable OXX - Right Hand		
 Triple Unit - Double Operable OXX - Left Hand	 Triple Unit - Double Operable XXO - Right Hand		

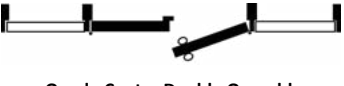
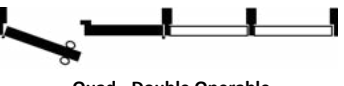
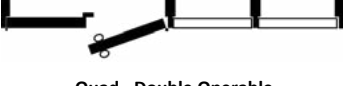
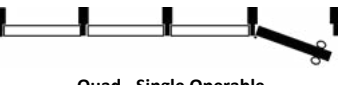
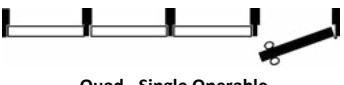
OUTSWING

X = Operating door O = Fixed door
Point of Reference = Standing on the Exterior side of Unit

 Single X - Right Hand	Interior  Exterior Single X - Left Hand
 Double XX - Right Hand	 Double XX - Left Hand
 Patio - Center Hinge OX - Right Hand	 Patio - Center Hinge XO - Left Hand
 Patio - Jamb Hinge XO - Right Hand	 Patio - Jamb Hinge OX - Left Hand
 Triple Unit - Center Operable OXO - Right Hand	 Triple Unit - Center Operable OXO - Left Hand
 Triple Unit - Single Operable OOX - Right Hand	 Triple Unit - Single Operable XO - Left Hand
 Triple Unit - Single Operable XOO - Right Hand	 Triple Unit - Single Operable OOX - Left Hand
 Triple Unit - Double Operable XOX - Right Hand	 Triple Unit - Double Operable OXX - Left Hand
 Triple Unit - Double Operable OXX - Right Hand	 Triple Unit - Double Operable XOX - Left Hand

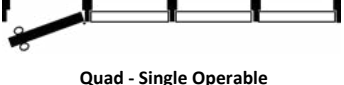
 Quad - Double Operable OOX - Right Hand	 Quad - Double Operable OOX - Left Hand
 Quad - Center Double Operable OXXO - Right Hand	 Quad - Center Double Operable OXXO - Left Hand
 Quad - Double Operable XXOO - Right Hand	 Quad - Double Operable XXOO - Left Hand
 Quad - Single Operable OOX - Right Hand	 Quad - Single Operable OOX - Left Hand
 Quad - Single Operable OOXO - Right Hand	 Quad - Single Operable OOXO - Left Hand
 Quad - Single Operable OXOO - Right Hand	 Quad - Single Operable OXOO - Left Hand
 Quad - Single Operable XOOO - Right Hand	 Quad - Single Operable XOOO - Left Hand

MOLDED DOOR CUTDOWN RANGES

JELD-WEN



CARRARA

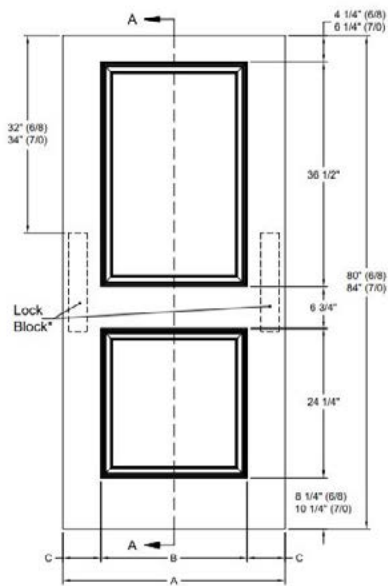

RANGE	
SLAB (1 PANEL)	
54-1/2"	63-1/2"
UNIT	
56-5/8"	65-5/8"
SLAB (2 PANEL)	
85-1/2"	95-1/2"
UNIT	
87-5/8"	97-5/8"

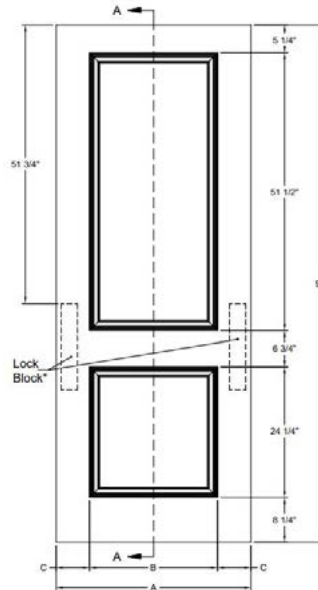

RANGE	
SLAB (1 PANEL)	
39-1/2"	47-1/4"
UNIT	
41-5/8"	49-3/4"
SLAB (1 PANEL)	
27-1/4"	38-3/4"
UNIT	
29-3/4"	40-7/8"
SLAB (2 PANEL)	
54-1/2"	79-1/2"
UNIT	
56-5/8"	81-5/8"

ROCKPORT

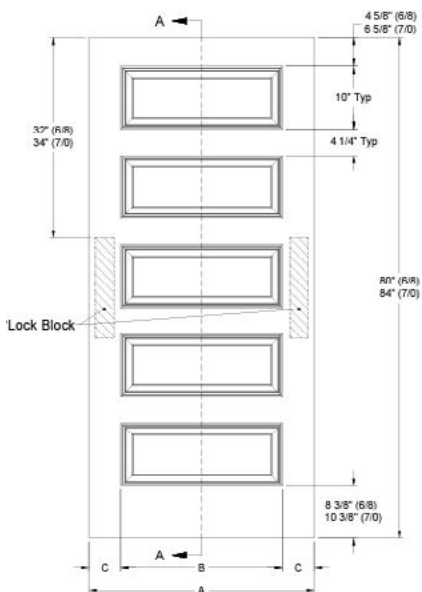

RANGE	
SLAB (6 PANEL)	
84-1/4"	95-1/2"
UNIT	
86-3/8"	97-5/8"

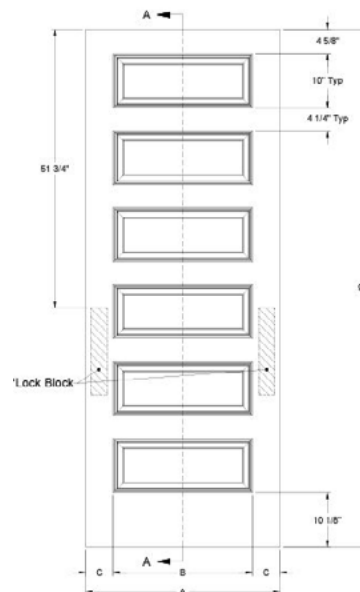

RANGE	
SLAB (2 PANEL)	
28-7/8"	33-7/8"
SLAB (3 PANEL)	
41-1/2"	48-1/8"
SLAB (4 PANEL)	
55-3/4"	62-3/8"
SLAB (5 PANEL)	
70"	79-1/2"

SANTA FE

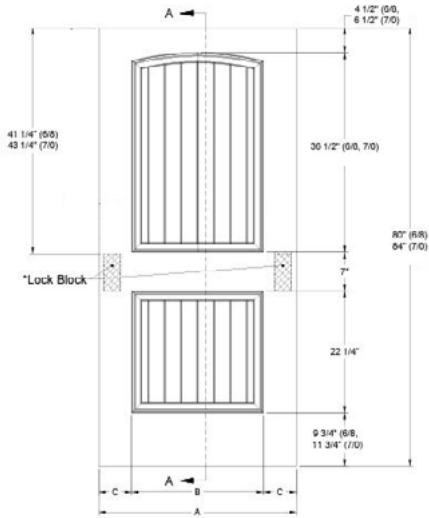

RANGE	
SLAB (1 PANEL)	
55-1/2"	63-7/8"
UNIT	
57-5/8"	66"
SLAB (2 PANEL)	
84-3/4"	95-1/2"
UNIT	
86-7/8"	97-5/8"

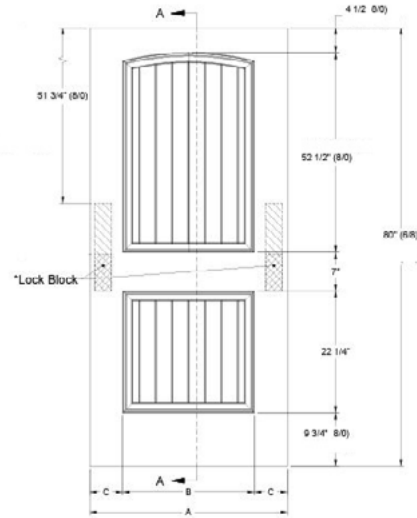

RANGE	
SLAB (1 PANEL)	
39-1/2"	47-7/8"
UNIT	
41-5/8"	50"
SLAB (1 PANEL)	
25-1/4"	38-5/8"
UNIT	
27-3/8"	40-6/8"
SLAB (2 PANEL)	
54-1/2"	40-6/8"
UNIT	
56-5/8"	81-5/8"

CAIMAN

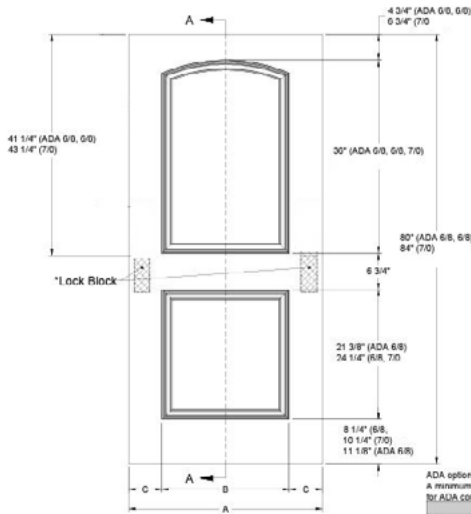

RANGE	
SLAB (1 PANEL)	
53"	63-1/2"
UNIT	
55-1/8"	65-5/8"
SLAB (1 PANEL)	
87-3/4"	95-1/2"
UNIT	
89-7/8"	97-5/8"

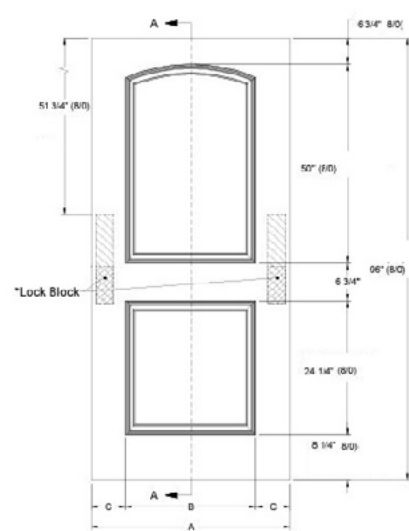

RANGE	
SLAB (1 PANEL)	
39-1/2"	47-1/2"
UNIT	
41-5/8"	49-3/4"
SLAB (1 PANEL)	
27-1/4"	38-3/4"
UNIT	
29-3/8"	40-7/8"
SLAB (2 PANEL)	
70"	79-1/2"
UNIT	
72-1/8"	81-5/8"

MOLDED DOOR CUTDOWN RANGES

JELD-WEN



COLONIST

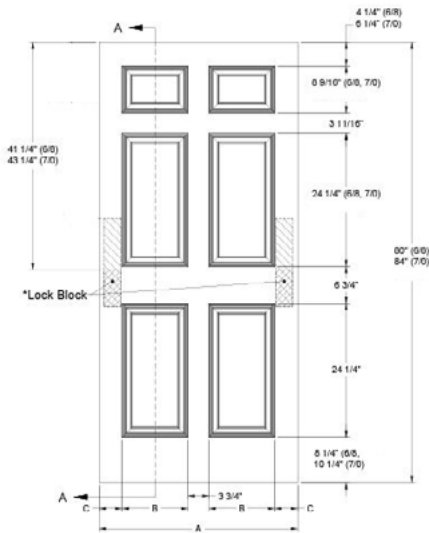

RANGE	
SLAB (4 PANEL SHORT)	
54-1/2"	63-1/2"
SLAB (4 PANEL TALL)	
71-2/8"	79-6/8"
SLAB (6 PANEL)	
88-1/2"	95-1/2"

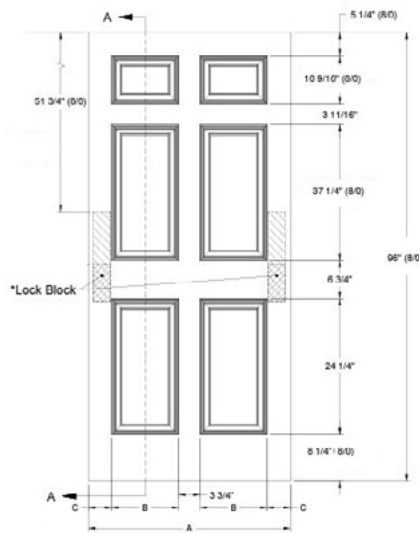

RANGE	
SLAB (1 PANEL)	
27-1/4"	38-3/4"
SLAB (4 PANEL SHORT)	
31"	39"
SLAB (4 PANEL TALL)	
58-1/4"	66-3/4"
SLAB (6 PANEL)	
74-3/4"	79-1/2"

MADISON

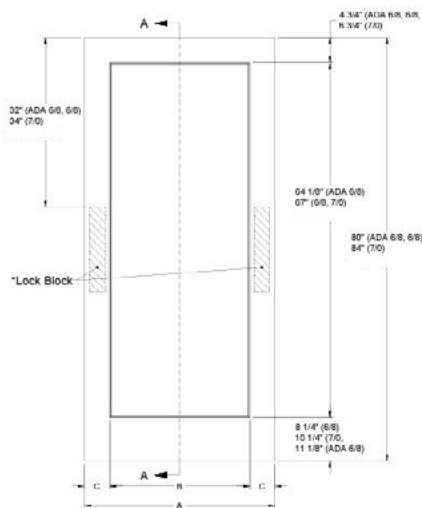

RANGE	
SLAB	
84"	95-1/2"
UNIT	
86-1/8"	97-5/8"

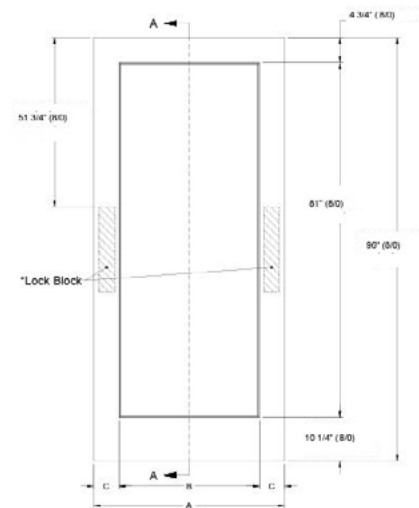

RANGE	
SLAB	
70"	79-1/2"
UNIT	
72-1/8"	81-5/8"

MONROE

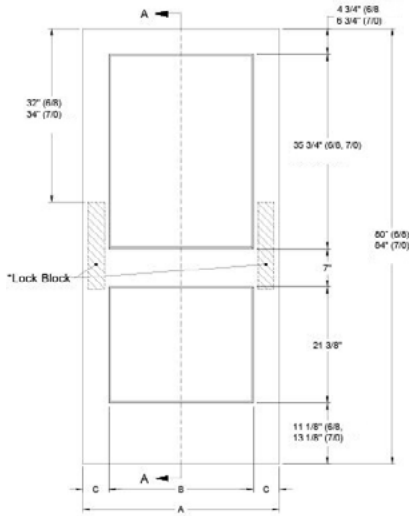

RANGE	
SLAB (1 PANEL)	
54-3/4"	63-1/2"
UNIT	
56-7/8"	65-5/8"
SLAB (2 PANEL)	
83-1/8"	95-1/2"
UNIT	
85-2/8"	97-5/8"

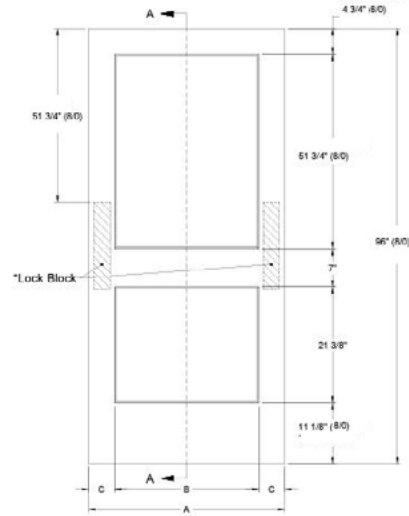

RANGE	
SLAB (1 PANEL TALL)	
38-3/4"	47-1/2"
SLAB (1 PANEL SHORT)	
24-3/8"	39"
SLAB (2 PANEL)	
67-1/8"	79-1/2"

BIRKDALE

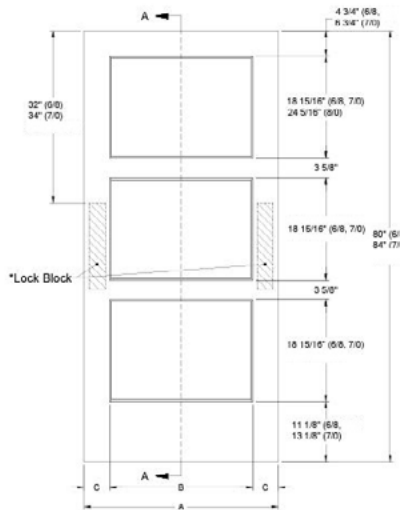

RANGE	
SLAB (1 PANEL)	
27-1/3"	38-4/9"
SLAB (2 PANEL)	
55-1/4"	65-3/8"
SLAB (3 PANEL)	
83-1/4"	95-1/2"

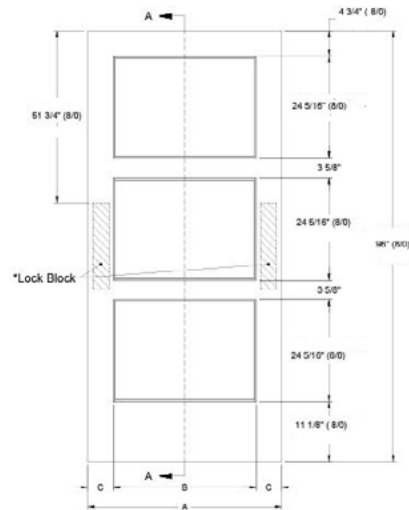

RANGE	
SLAB (1 PANEL)	
24"	33-1/4"
SLAB (2 PANEL)	
44-1/2"	55-4/5"
SLAB (3 PANEL)	
67"	79-1/2"

MOLDED DOOR CUTDOWN RANGES

JELD-WEN



CONMORE

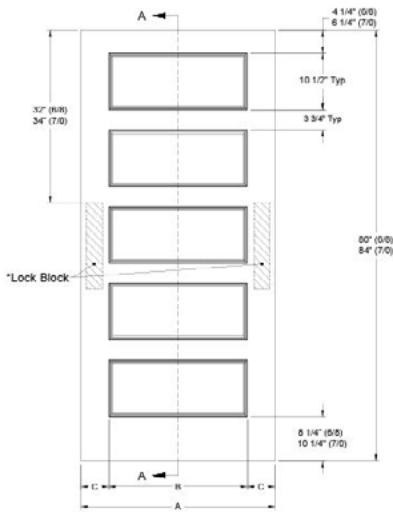

RANGE	
SLAB (1 PANEL)	
84-3/4"	95-1/2"
UNIT	
86-7/8"	97-5/8"

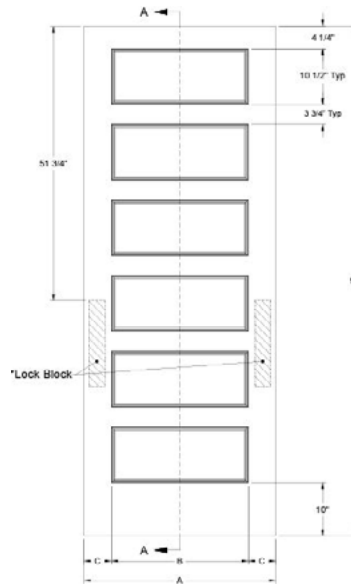

RANGE	
SLAB (1 PANEL)	
27-3/4"	36-3/8"
UNIT	
41-7/8"	50-4/7"
SLAB (1 PANEL)	
56"	64-3/4"
UNIT	
70-1/4"	79-1/2"

CAMDEN

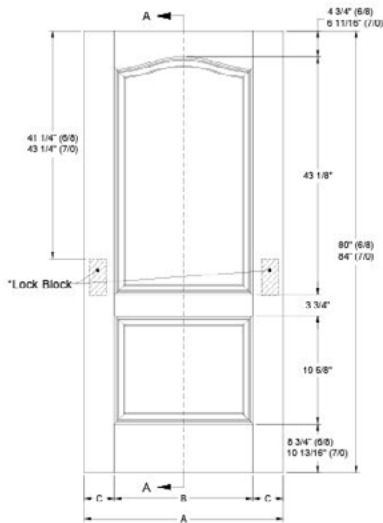

RANGE	
SLAB (TOP PANEL)	
46-1/8"	52-1/4"
SLAB (BOTTOM PANEL)	
22-5/8"	31"
SLAB	
69-1/2"	79-1/2"

CRAFTSMAN III

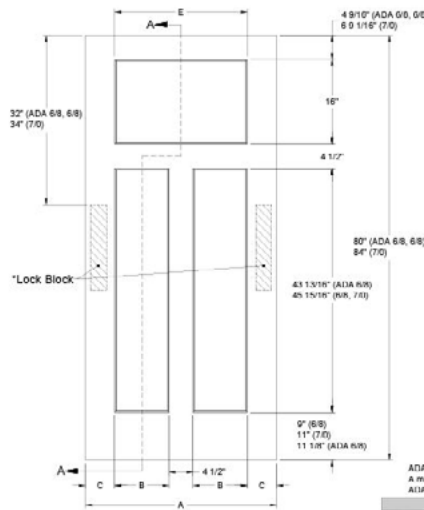

RANGE	
SLAB (TOP PANEL)	
19"	25-1/4"
SLAB (BOTTOM PANEL)	
49"	58-7/8"
SLAB	
69-4/9"	79-1/2"

GLASS★CRAFT®
DOOR COMPANY

SPECIAL ORDER ONLY



2 Panel Speakeasy

- Shown as 36" wide door, with:
- Premium or Pro Series
 - Artisan Laurel Grey Distressed
 - Florentine Speakeasy Grille
 - Clear glass



NP 4 Block Left

- 36" wide Narrow Profile door shown here with:
- 4 Block Left configuration
 - Cloud Glass
 - Tricorn Black paint color



Santa Monica 4 Lite

- Shown as 36" wide door, with:
- Premium or Pro Series
 - Pro Metro frame glazed
 - Estate Smoke finish
 - Cloud glass option



3/4 SDL 6 Lite

- Shown as 36" wide door, with:
- V-Groove panel option
 - 1" wide muntin bars
 - Artisan Onyx Distressed finish
 - Flemish glass texture



Craftsman 3 Panel

- Shown as 36" wide Value Series Shaker style door, with:
- Shoji White Palette Collection painted finish



Full Lite with Blinds

- Shown as 36" wide Value Series door, with:
- Shoji White Palette Collection painted finish
 - Clear LowE glass

* Doors shown above are 95.25" tall, most are also available at 79.25", and in varied widths.



2 Panel Speakeasy

Shown as 36" wide V-Grooved Estancia Knotty Alder door, with:

- Owl Grey Traditional finish
- Seville speakeasy grille
- Rain glass



3/4 Lite Mahogany

36" wide Portobello Mahogany door, shown with:

- Raised moulding standard
- Slate Grey Traditional finish
- Reeds glass



Beverly 6 Lite

36" wide Portobello Mahogany door, shown with:

- Winter Antique finish
- Water glass



3/4 Lite Warwick

36" wide Estancia Knotty Alder door, shown here with:

- Warwick Wrought Iron grille
- Owl Grey Traditional finish
- Antique glass



Craftsman 4-Lite

36" wide 3 Panel Mahogany SDL door shown with:

- Forest Grey Traditional finish
- Dentil Shelf option
- Clear glass



6 Lite TDL

36" wide Estancia Knotty Alder door, shown here with:

- Canyon Brown finish
- Antique glass

* Doors shown above are 96" tall, most are also available at 80", and in varied widths.



Plank Barn Door

- Shown as 36" x 96" door, with:
- Slade stainless steel hardware
 - Barnwood Ranch Brown finish
 - Corona pull handle



Double Z Barn Door

- Shown as 30" x 96" door, with:
- Slade hardware
 - Owl Grey Distressed finish
 - San Juan 24" pull handle



Horizontal Iron Plank

- Shown as 42" x 96" door, with:
- Royal hardware
 - Winter Antique finish
 - Vista inset pull handle

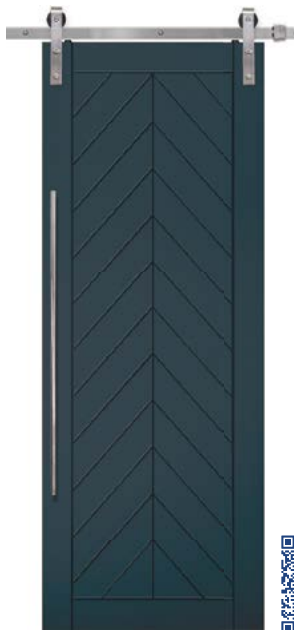

Chevron MDF Door

- Shown as 36" x 96" door, with:
- Slade stainless steel hardware
 - Gale Force paint finish
 - Metro 48" pull handle



Triple X MDF Door

- Shown as 36" x 96" door, with:
- Gage hardware
 - Grey Clouds paint finish
 - Tucson 24" pull handle



Rustic Farmhouse Chevron 1

- Shown as 42" x 96" door, with:
- Vintage hardware
 - Barnwood, Riverwood, Stormy Grey, and Weathered Brown plank colors
 - Gila 24" pull handle



**Contemporary Metal
6 Lite/1 Panel**

Shown as 36" x 96" door, with:

- Gage hardware
- Clear glass option
- Door pull included



Contemporary Metal 4 Lite

Shown as 48" x 96" door, with:

- Gage hardware
- Cloud glass option
- Door pull included



**Contemporary Birch
Mirror Full Lite**

Shown as 36" x 84" door, with:

- 28" x 68" Mirror
- Waggoner hardware
- Winter Antique finish
- Gila 24" pull handle



**Contemporary Birch
Santa Monica 4 Lite**

Shown as 36" x 96" door, with:

- Slade stainless steel hardware
- Water glass option
- Canyon Brown Distressed finish
- Metro 60" pull handle



Mahogany 6 Lite SDL

Shown as 36" x 96" door, with:

- Slade stainless steel hardware
- Clear glass option
- Forest Grey Antique finish
- Metro 12" stainless steel pull



Mahogany Beverly 5 Lite

Shown as 36" x 80" door, with:

- Gage hardware
- Cloud glass option
- Owl Grey Antique finish
- Metro 12" pull handle





DOOR & MILLWORK

PATIO DOORS

ATRIUM (SPECIAL ORDER)

SERIES 312 - SLIDING PATIO DOOR



SERIES 312

SLIDING PATIO DOOR

- + Offered in range of sizes: 5', 6', 6'4", 8', 9', even 12'
- + Custom sizes available
- + Available in 6'8" height up to 12' wide
- + Field reversible (not available with BBG)
- + Aluminum track for moving panel
- + Easy installation in new construction applications
- + Screen comes standard*
- + Deluxe color-matched hardware
- + Keyed lock standard

CUSTOM Options

- + Low-E Glass
- + Low-E Glass + Argon Gas
- + Ultra Low-E Glass + Argon Gas
- + 5/8" or 3/4" flat, 5/8" or 1" contoured, 5/8" contoured valance and distinctive diamond pattern grids available
- + 1 1/8" Simulated Divided Lite
- + Light and dark shades of oak or cherry interior wood laminate and black exterior laminate
- + Side lites; transoms and specialty shapes; upgraded, deluxe heavy-duty screen*
- + Pet resistant screen*
- + Brass, brushed nickel or oil rubbed bronze hardware
- + Available in 5', 6', 6'4", 8', 9', and 12' configurations



BLINDS Between the Glass Option

Available in 6068 with white, almond and clay vinyl, interior and exterior laminates and painted exterior colors. Blinds, operators and glass panels available in white only.

NEW Also available in 5068 (white only).

NEW black exterior laminate color shown with optional blinds between the glass (available in 6068 only).



Easy to raise, lower and tilt blinds.



Controls light and privacy.



Never needs dusting and is safe for pets and children.

VINYL COLOR** OPTIONS



PAINTED EXTERIOR COLOR** OPTIONS



WOOD LAMINATE COLOR** OPTIONS



Select styles and glass packages can be ordered to meet ENERGY STAR® 7 guidelines. See your Atrium Territory Sales Manager for details.



Note: Manufacturer reserves the right to substitute components as necessary for continued product improvement.
 * Screens are not meant to restrain a child from falling through an open window.
 ** Printing process may affect color shown. Please refer to actual window sample when selecting colors.
 *** Grid offering limited to 5/8" contoured or SDL on exterior or painted windows. Only use mild, water based household cleaner on painted product and rinse immediately with water. See full cleaning instructions for details.
 REV 11/23

PART OF THE CORNERSTONE BUILDING BRANDS FAMILY

SERIES 332
SLIDING PATIO DOOR

- + Easy installation in new construction applications with built-in 4 9/16" jamb
- + Field reversible (6'8" height only; not available with BBG)
- + DP-50 Rating great for coastal applications (on 5068, 6068 and 8068 doors)
- + Deluxe color matched hardware
- + Custom sizes available
- + Multi-Point keyed lock
- + Available in 8' height
- + Available in 6'8" height up to 12' wide
- + Heavy-Duty Screen included*
- + Limited Lifetime Warranty



CUSTOM Options

- + Low-E Glass
- + Low-E Glass + Argon Gas
- + Ultra Low-E Glass + Argon Gas
- + 5/8" or 3/4" flat, 5/8" or 1" contoured, 1 1/8" Simulated Divided Lite grids available
- + Nine exterior painted colors, three interior wood laminates, black exterior laminate
- + Brass, brushed nickel or oil rubbed bronze hardware
- + Pet resistant screen*

VINYL COLOR OPTIONS**



PAINTED EXTERIOR COLOR OPTIONS**



WOOD LAMINATE COLOR OPTIONS**



BLINDS Between the Glass Option

Available in 6068 with white, almond and clay vinyl, interior and exterior laminates and painted exterior colors. Blinds, operators and glass panels available in white only.

NEW black exterior laminate color shown with optional blinds between the glass.



Easy to raise, lower and tilt blinds.



Controls light and privacy.



Never needs dusting and is safe for pets and children.



Select styles and glass packages can be ordered to meet ENERGY STAR® 7 guidelines. See your Atrium Territory Sales Manager for details.



Note: Manufacturer reserves the right to substitute components as necessary for continued product improvement.
 * Screens are not meant to restrain a child from falling through an open window.
 ** Printing process may affect color shown. Please refer to actual window sample when selecting colors.
 *** Grid offering limited to 5/8" contoured or SDL on exterior painted windows. Only use mild, water based household cleaner on painted product and rinse immediately with water. See full cleaning instructions for details.
 REV 11/23

V2000 PATIO DOOR

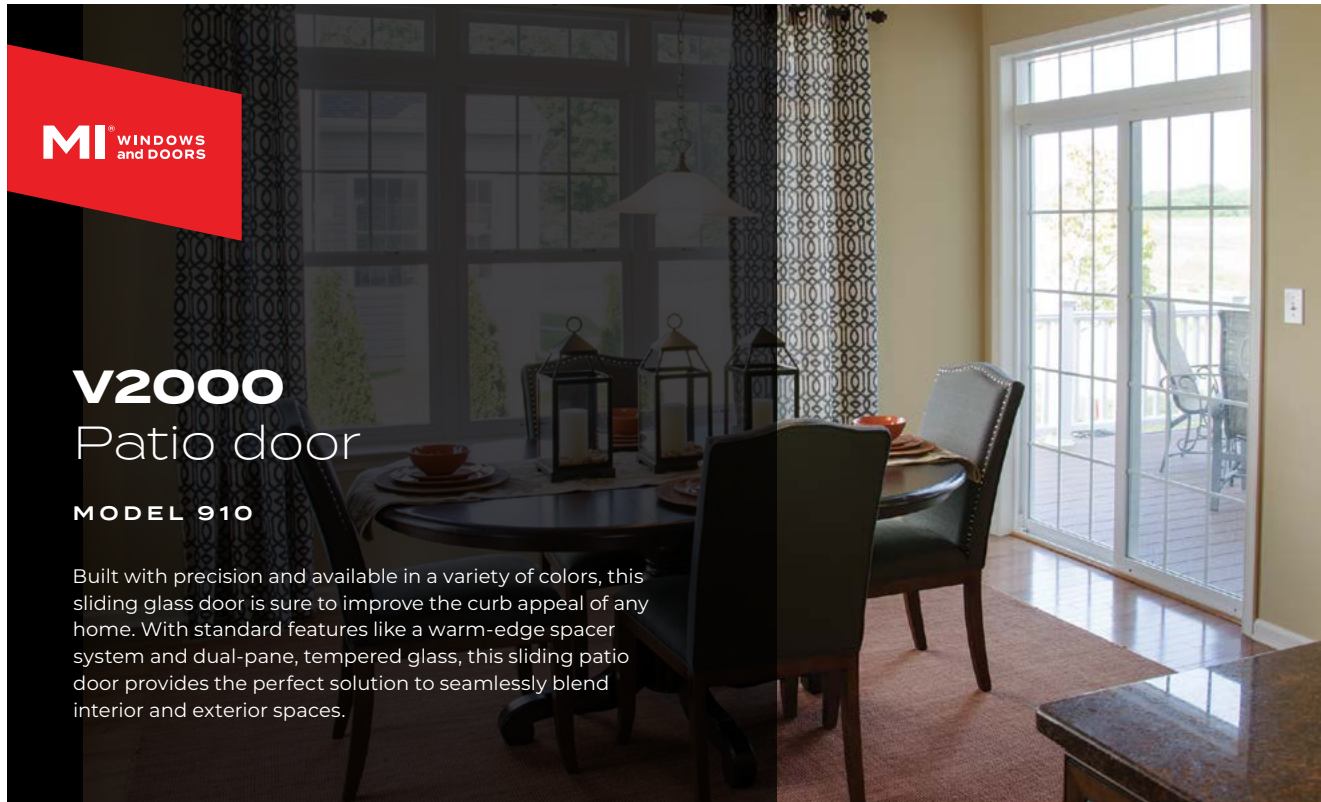

MI[®] WINDOWS
and DOORS

V2000 Patio door

MODEL 910

Built with precision and available in a variety of colors, this sliding glass door is sure to improve the curb appeal of any home. With standard features like a warm-edge spacer system and dual-pane, tempered glass, this sliding patio door provides the perfect solution to seamlessly blend interior and exterior spaces.



What you can expect

ENERGY EFFICIENCY

Our dual-pane insulated glass package options help save on heating and cooling costs while enhancing home comfort.

- In cool weather, it provides outstanding thermal performance to eliminate cold spots near windows.
- In warm weather, insulated glass reduces solar heat gain and minimizes interior glare.

CONVENIENCE AND STYLE

- Metal rollers with tandem ball bearings provide for smooth, effortless operation
- Aluminum roll panel track is sturdy and easy to clean
- Panel interlock helps reduce air infiltration
- Insulated double-strength tempered glass adds strength and dependability
- Optional exterior key lock increases peace-of-mind and convenience

Engineered to perform

- Available frame styles: mounting fin, finless
- 4 ¾" frame depth
- J-channel and brickmould options available

Energy efficient glass

Optional tempered glass adds additional strength and obscure or rain glass allows light in while protecting privacy.

GLAZING TYPE	U-VALUE	SHGC
Low-E glass	0.32	0.32
Low-E glass with grids	0.32	0.28
Argon and Low-E glass	0.28	0.32
Argon and Low-E glass with grids	0.28	0.28
HP Low-E glass	0.32	0.23
HP Low-E glass with grids	0.32	0.21
Argon and HP Low-E glass	0.28	0.23
Argon and HP Low-E glass with grids	0.28	0.21
Thermal Upgrade: Argon Low-E glass	0.28	0.32
Thermal Upgrade: Argon and Low-E glass with grids	0.28	0.28

Note: all values based on 3/4" standard dual-pane insulated glass unit unless noted otherwise

Sizing & operation

PANELS	PANEL OPERATION View from Outside In	STANDARD SIZES		CUSTOM SIZES			
		WIDTH		WIDTH		HEIGHT	
		CODE	EXACT	MIN	MAX	MIN	MAX
2-Panel		(50)	59 5/8"	47 1/2"	95 5/8"	71"	95 1/2"
		(60)	71 5/8"				
		(80)	95 5/8"				
Field-Mulled Sidelite		(26)	29 1/4"	12"	48"	71"	95 1/2"
		(30)	35 1/4"				
		(40)	47 1/4"				
X=operating; O=stationary; S=sidelite		Available heights (6/8) 79 1/2" (8/0) 95 1/2"					

Create a customized look

Enhance your home's spaces with a variety finish options and grid configurations.

FINISH OPTIONS

EXTERIOR	INTERIOR
White EXTRUSION	White EXTRUSION
Almond PAINT ◊ / EXTRUSION	Almond EXTRUSION †
Clay PAINT ◊ / EXTRUSION †	Clay EXTRUSION †
Cocoa PAINT ◊	
Cream PAINT ◊	
Forest Green PAINT ◊	
Bronze LAMINATE † / PAINT ◊	
Black Matte LAMINATE † / PAINT ◊	

GRID TYPES



HARDWARE OPTIONS

- COLOR-MATCHED TO DOOR FRAME**
- White
 - Almond
 - Clay
 - Silver exterior (for paint)
 - Black exterior (for laminate)

V2000 PATIO DOOR
See additional product and warranty information online.



† Exterior laminate available with white interior only; has a satin finish (matte applies to black paint only)
◊ Exterior paint not available with brickmould

MI Build boldly by choosing a range of MI window and door styles with expansive views, contemporary framing and hardware.

V3000 PATIO DOOR

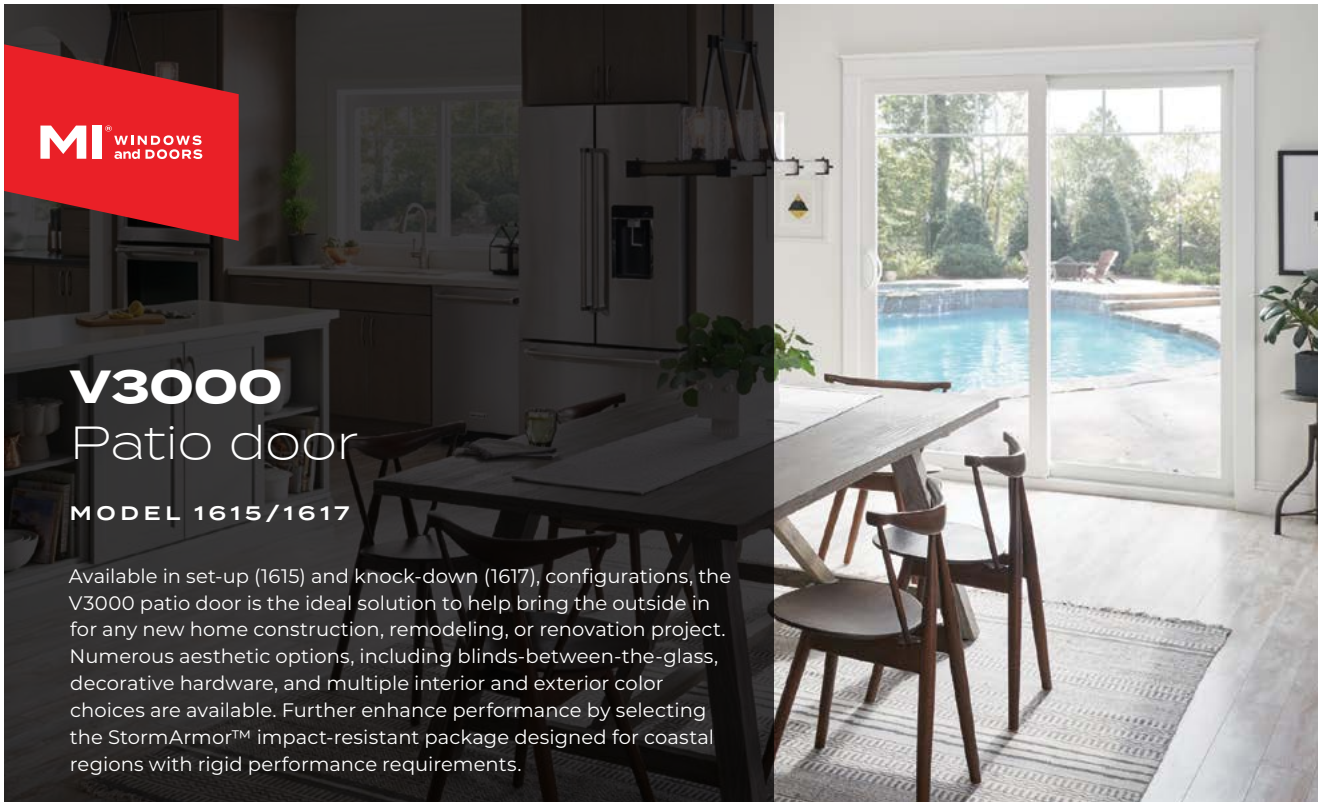

MI[®] WINDOWS
and DOORS

V3000 Patio door

MODEL 1615/1617

Available in set-up (1615) and knock-down (1617), configurations, the V3000 patio door is the ideal solution to help bring the outside in for any new home construction, remodeling, or renovation project. Numerous aesthetic options, including blinds-between-the-glass, decorative hardware, and multiple interior and exterior color choices are available. Further enhance performance by selecting the StormArmor™ impact-resistant package designed for coastal regions with rigid performance requirements.



What you can expect

ENERGY EFFICIENCY

Our dual- and triple-pane insulated glass package options help save on heating and cooling costs while enhancing home comfort.

- In cool weather, it provides outstanding thermal performance to eliminate cold spots near windows.
- In warm weather, insulated glass reduces solar heat gain and minimizes interior glare.

CONVENIENCE AND STYLE

- Saddle sill with heavy-duty dual tandem nylon rollers provide for smooth, effortless operation
- Raised rail protects wheels from debris
- Aluminum track is sturdy and easy to clean
- Panel interlock helps reduce air infiltration
- Insulated double-strength tempered glass adds strength and dependability
- Dual-point mortised lock for enhanced safety
- Optional foot lock, security bar, and exterior key lock increases peace-of-mind and convenience

Engineered to perform

- Available frame styles: finless, sealing fin
- 4 3/16" frame depth (5 3/8" including screen track)
- Optional StormArmor™ package includes impact-resistant glass with argon, Cardinal LoE³-366, and preserve film to protect the glass until installation is complete
- Optional DP-50 package on select configurations



Energy efficient glass

Standard tempered glass adds additional strength and allows light in while protecting privacy.

GLAZING TYPE	U-VALUE	SHGC	STC
Argon and Low-E glass	0.29	0.28	29
Argon and Low-E glass with grids	0.29	0.25	29
Argon and HP Low-E glass	0.29	0.20	29
Argon and HP Low-E glass with grids	0.29	0.18	29
Triple-pane with argon and Low-E glass	0.25	0.24	n/a
Triple-pane with argon and Low-E glass with grids	0.27	0.22	n/a
Impact-resistant laminated glass with Argon and LoE ³ -366	0.33	0.20	24
Impact-resistant laminated glass with Argon , LoE ³ -366 with grids	0.36	0.18	24
Impact-resistant laminated glass with Argon and LoE ³ -340	0.33	0.14	24
Impact-resistant laminated glass with Argon , LoE ³ -340 with grids	0.36	0.13	24

Note: all values based on 7/8" standard dual-pane or 1" dual-pane laminated insulated glass unit unless noted otherwise

Sizing & operation

PANELS	PANEL OPERATION View from Outside In	STANDARD SIZES		CUSTOM SIZES			
		WIDTH		MIN	MAX	MIN	MAX
		CODE	EXACT				
2-Panel		(50)	58 7/8"	52"	96"	63"	95 1/2"
		(60)	70 7/8"				
		(80)	94 1/2"				
3-Panel		(90)	106 1/4"	80"	142"	63"	95 1/2"
		(120)	141 1 1/4"				
3-Panel*		(90)	103 1/2"	80"	139"	63"	95 1/2"
		(120)	138 1 5/8"				
4-Panel*		(100)	115 7/16"	96"	187 3/4"	63"	95 1/2"
		(120)	139 7/16"				
		(160)	186 1 1/4"				

*Available as 1617 knockdown only

X=operating; O=stationary

Available heights
(68) 79 1/2" or (80) 95 1/2"

= Available with StormArmor

† Clay interior may only be combined with clay extruded exterior; not available with triple-pane glass

‡ Woodgrain interior not available with black or clay exterior

§ Blinds-between-the-glass available for dual-pane glass only; not available with StormArmor; available in white color only

* Standard handles are color-matched to door frame; black handle is available for exterior only and must be combined with white interior handle; brushed chrome is standard on painted and laminated products

‡ XX Recessed exterior black handle standard

V3000 PATIO DOOR
See additional product and warranty information online.



Create a customized look

Enhance your home's spaces with a variety of finish options and grid configurations.

FINISH OPTIONS

EXTERIOR	INTERIOR
White EXTRUSION	White EXTRUSION
Almond PAINT / EXTRUSION	Almond EXTRUSION
Clay PAINT / EXTRUSION	Clay EXTRUSION†
Cocoa PAINT	Hillside Oak LAMINATE ‡
Cream PAINT	Natural Oak LAMINATE ‡
Forest Green PAINT	Colonial Cherry LAMINATE ‡
Bronze PAINT	
Black Matte PAINT	
Silver PAINT	

GRID AND BLIND TYPES



HARDWARE OPTIONS*

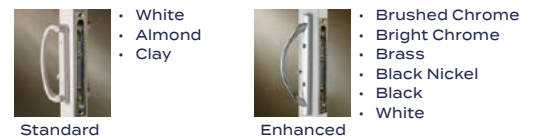

ADDITIONAL FEATURES*



MI[®] Build boldly by choosing a range of MI window and door styles with expansive views, contemporary framing and hardware.

SHOWCASE (SPECIAL ORDER)

MULTI-PANEL SLIDING PATIO DOOR



623 Series Multi-Panel Sliding Patio Door



- Integral nailing fin on jambs and head; jamb size 4-9/16"
- Reinforced vertical panel
- Easy assembly saves time and effort on the job
- Easy-glide tandem ball bearing rollers on stainless steel track
- Heavy duty sliding screen
- Tempered insulating glass
- Improved weep system for superior weather performance
- Streamlined design gives better access to movable hardware
- Numerous handle and grid options



Standard stainless steel rollers and track



Legacy Style Hand Set



1/4" High

Internal Grid Options



3/4" Flat



5/8" Sculptured

Traditions® SDL (Simulated Divided Lite) Bars

- Made from solid cellular PVC
- 1-1/8" or 7/8" wide profiles
- with or without shadow bars
- Standard and custom patterns
- Color matched (on most products - contact Showcase)

Designer Color Choices:

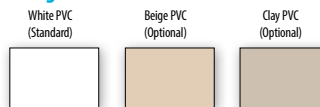

Optional Exterior/Interior Laminates

- Bronze Exterior
- Black Exterior
- Black Interior
- White Interior



Colors shown may vary slightly from the actual color due to differences between paper printing and product production. Check with your Showcase representative if you would like a color sample. Sill colors match frames, including 2-tone.

2, 3 and 4-Panel Doors:

- Up to 12' x 8' available in DP-50 Impact configurations
- Up to 16' x 10' available in Standard configurations

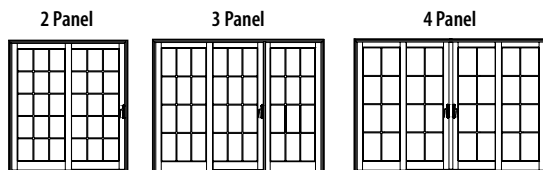

(Patio Door operation is always viewed from outside)

OXXO - French Sliding Door Only



*Scan the QR Code for installation video



DOOR & MILLWORK

PREMIUM PATIO DOORS

NEUMA DOORS (SPECIAL ORDER)

PATIO DOORS



Neuma Doors is your source for beautiful, durable fiberglass exterior doors. We offer a variety of doors including hinged, gliding, bypass gliding, and folding doors with glass options including impact for those in coastal and non-impact for those away from the coast.

With a full composite jamb and fiberglass skin, Neuma Doors are designed for better water infiltration protection than standard wood jamb doors. Built with a solid core and using LoE 366 glass standard, you get a very energy-efficient door providing better insulation against hot and cold temperatures outside.

Take a tour of our website to see more about our offerings and visit your local dealer to learn more about adding Neuma Doors to your next project.



WWW.NEUMADOORS.COM |

Features and Benefits

□ Sizing

- Standard sizing in 9', 12', and 15' x 8' in 3 panel Configuration.
- Standard sizing in 12', 16', and 20' x 8' in 4 panel Configuration.
- Maximum panel size is 5' x 8' or 40 sq ft.
- Maximum frame width of 3 panel door system at 15'.
- Maximum width of 4 panel door system at 20'.
- Custom sizing available.

□ Frame

- KD or welded main frame.
- 7 $\frac{3}{4}$ " total width 6 $\frac{3}{4}$ " jamb depth all PVC multi-chambered profile frame system (on 3 panel).
- 10 $\frac{3}{8}$ " total width 9 $\frac{3}{8}$ " jamb depth all PVC multi-chambered profile frame system (on 4 panel).
- Integrated nail fin application with 1" or 1 $\frac{3}{8}$ " set back.
- Full length weather stripping on all 4 frame components.
- Integrated sill drainage with snap-in sill covers.

□ Sash

- Fully welded vinyl sash with internal aluminum reinforcement with $\frac{7}{8}$ " standard IG, or a 1 $\frac{1}{4}$ " triple insulated glass system.
- Many high energy-efficient glass options for the most extreme temperature sensitive regions.
- Standard glazing, Cardinal™ LoE 366® dual glazed tempered glass.
- All stiles are metal reinforced for extreme wind load resistance.
- Unique internal drainage system to minimize risk of seal failures.
- Interior glazed for better performance.

□ Hardware

- Truth Nexus 2 point lock with opposing lock points.
- Anti-lock feature preventing a "false" sense of lock up.
- Flush mount handle - does not protrude into the room.
- Deep finger pocket - provides superior grip area for moving large door panels.
- Recessed thumb slide intuitive locking and unlocking of panel.
- Stainless steel roller housing and composite wheels with side adjustment, AAMA rated to carry a 500 pound panel for 10,000 cycles without change to adjustment.
- Hardware colors; white, black powder coat, and brushed chrome.

□ Extruded Vinyl Colors



□ Optional Exterior Coated Stocked Colors



□ Optional

- Black Interior and Exterior Specialty Laminate

Featuring Jet Black



Signature

Flush Mount



www.windorsystems.com

V3000 MULTI-SLIDE PATIO DOOR



What you can expect

ENERGY EFFICIENCY

Our dual- and triple-pane insulated glass package options help save on heating and cooling costs while enhancing home comfort.

- In cool weather, it provides outstanding thermal performance to eliminate cold spots near windows.
- In warm weather, insulated glass reduces solar heat gain and minimizes interior glare.

CONVENIENCE AND STYLE

- Saddle sill with heavy-duty dual tandem nylon rollers provide for smooth, effortless operation
- Raised rail protects wheels from debris
- Aluminum track is sturdy and easy to clean
- Panel interlock helps reduce air infiltration
- Insulated double-strength tempered glass adds strength and dependability
- Dual-point mortised lock for enhanced safety
- Optional foot lock, security bar, and exterior key lock increases peace-of-mind and convenience

Engineered to perform

- Available frame styles: finless, fin
- 6 7/8" frame depth
- Optional StormArmor™ package on XIX configurations
- Optional DP-50 package on select configurations



Energy efficient glass

Standard tempered glass adds additional strength and allows light in while protecting privacy.

GLAZING TYPE	U-VALUE	SHGC
Argon and Low-E glass	0.29	0.28
Argon and Low-E glass with grids	0.29	0.25
Argon and HP Low-E glass	0.29	0.20
Argon and HP Low-E glass with grids	0.29	0.18
Triple-pane with argon and Low-E glass	0.25	0.24
Triple-pane with argon and Low-E glass with grids	0.27	0.21
Impact-resistant laminated glass with Argon and LoE ³ -366	0.31	0.20
Impact-resistant laminated glass with Argon , LoE ³ -366 with grids	0.33	0.18
Impact-resistant laminated glass with Argon and LoE ³ -340	0.31	0.14
Impact-resistant laminated glass with Argon , LoE ³ -340 with grids	0.33	0.12

Note: all values based on 7/8" standard dual-pane or 1" dual-pane laminated insulated glass unit unless noted otherwise

Sizing & operation

PANELS	PANEL OPERATION View from Outside In	STANDARD SIZES		CUSTOM SIZES			
		WIDTH		WIDTH		HEIGHT	
		CODE	EXACT	MIN	MAX	MIN	MAX
3-Panel		(72)	86"				
		(88)	104"	80"	144"	63"	95 1/2"
		(120)	139 7/16"				
6-Panel		(140)	169 1/4"	160"	216"	63"	95 1/2"
		(170)	205 1/8"				
X = operating; O = stationary; I = intermediate		Available heights (68) 79 1/2" (80) 95 1/2"					

* Screens are not available on XIX configuration
 * Standard handles are color-matched to door frame; black handle is available for exterior only and must be combined with white interior handle; brushed chrome is standard on painted and laminated products
 † Blinds-between-the-glass available for dual-pane glass only; available in white color only

V3000 MULTI-SLIDE DOOR
 See additional product and warranty information online.



Create a customized look

Enhance your home's spaces with a variety of finish options and grid configurations.

FINISH OPTIONS

EXTERIOR	INTERIOR
White EXTRUSION	White EXTRUSION
Clay PAINT	
Cocoa PAINT	
Cream PAINT	
Forest Green PAINT	
Bronze PAINT	
Black Matte PAINT	
Silver PAINT	

GRID TYPES



HARDWARE OPTIONS*

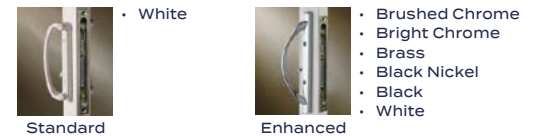

ADDITIONAL FEATURES*



MI Build boldly by choosing a range of MI window and door styles with expansive views, contemporary framing and hardware.



Multi-Slide Door
 Aluminum

Create the true experience of indoor outdoor living with industry-leading aluminum multi-slide patio doors.
 Our high-performance stacking multi-slide patio doors feature narrow, uniform sightlines to help you achieve your exact project vision.

SPECIFICATIONS

Panel Sizes

- Width: Min 24", Max 72"
- Height: Min 60", Max 144"

Frame Sizes

- Width: Min 43.5", Max 360"
- Height: Min 60", Max 144"

Configurations

- 2 to 5 one-way stacking panels
- Additional configurations to come

Attachment Method

- Block Frame

Performance

- PG 20
- U-factor 0.28-0.32
- SHGC 0.22

Sills

- Flush – 3/4"
- Performance – 1-1/2"

Stucco Returns

- 1"
- 1-3/8"

Sightline

- 2.43"

FRAME FINISHES



Satin Anodized



Black Anodized

HARDWARE

- Contemporary Pull
- Flush Handle
- Premium Adjustable Quad Rollers

HARDWARE FINISH OPTIONS



Satin Nickel (F42-R)



Matte Black (F9714)



Pivot Door

Aluminum



Add timeless sophistication to your design with the true modern styling of a Bonelli aluminum pivot door. With superior performance and options for every design, our pivot door solutions achieve your design vision without compromise.

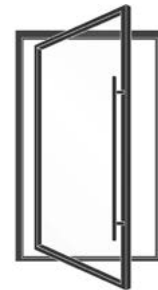

SPECIFICATIONS

5mm Insulating Glass Sizes*

- Max: 5'x9', 4.5'x10'

6mm Insulating Glass Sizes*

- Max: 5'x8', 180lbs.

* Larger sizes coming soon

Product Dimensions

- Standard: 5-1/4" bottom rail with 3-1/4" stiles and top rail
- Custom: 5-1/8" stiles and top rail

Configurations

- Left- or right-handed
- Interior or exterior pivot

Attachment Method

- Block Frame

Structural Performance

- DP 30

FRAME FINISHES



Satin Anodized



Black Anodized

HARDWARE

- Standard: 48" or 72" Ladder Pull
- Roller Catches with Deadbolt
- FritsJorgen Pivot System
- Custom: Electronic Deadbolt

HARDWARE FINISH OPTIONS



Satin Nickel (F42-R)



Matte Black (F9714)





IRON ENVY

IRON DOORS

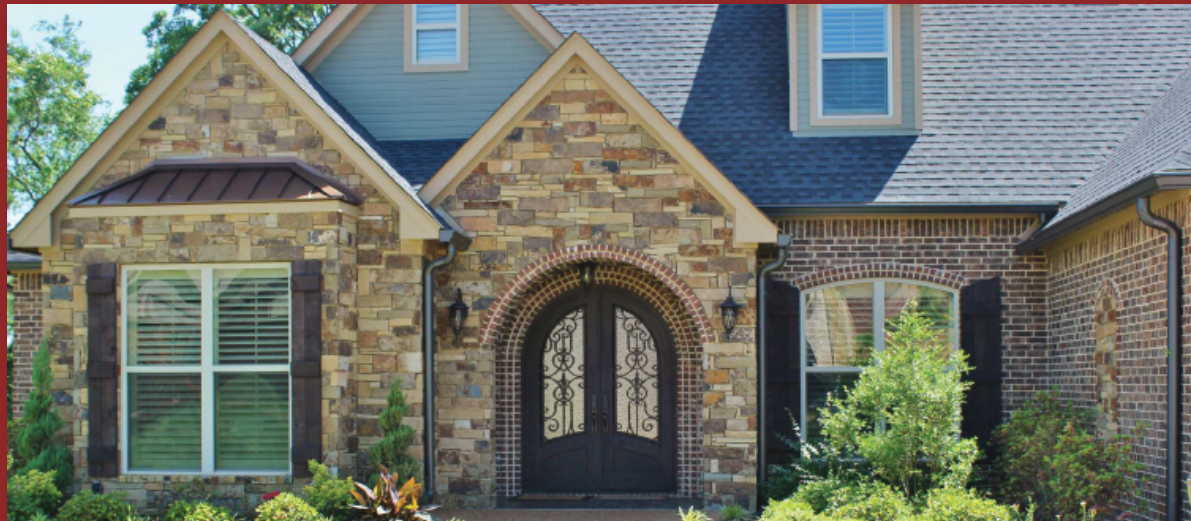

Be the Envy of your neighborhood with a new Iron Envy door from McCoy's

Iron Envy offers the finest handcrafted iron doors on the market. Our skilled artisans have over 25 years of experience. Choose from our in-stock options or create a custom design to fit your own personal style.

All Iron Envy styles are available in Straight, Eyebrow and Radius top configurations. Most standard sizes are in stock and available within 5-7 Business Days. Custom ordered styles and sizes are available within 12- 14 Weeks. See your McCoy's sales associate for details and availability.



3068 Unit
Dim. 39"x81" - 6" Jamb
(Handlesets Not Included)

3080 Unit
Dim. - 39"x96" - 6" Jamb
(Handlesets Not Included)

3680 Unit
Dim. - 46"x96" - 8" Jamb
(Handlesets Not Included)



IRON ENVY



6080 Unit / Dimensions 72"x96" – 8" Jamb (Handlesets Not Included)

All single and double doors are available in Straight Top, Eyebrow, and Full Radius styles.

CUSTOM DESIGNS

Let us make your door dreams a reality. We can create any size, design or configuration for your door, transom, sidelights, or wine door.

Vision Steel

Iron Envy's European inspired Vision Steel line is the perfect option for any design. The ultra-slim profile allows for maximum glass viewing area.

The Vision Steel line comes standard with clear dual paned Low-E glass for maximum energy efficiency. Reflective, Sandblast, Smoke, and Tea colored glass is also available for custom orders.



Choose from our stock designs or let us create a custom "Vision" just for you. See your McCoy's sales associate for custom orders or to see available inventory.





COMMERCIAL DOORS

THERE'S MORE TO TELL ...

GALVANNEALED STEEL

Our metal doors and frames are made from galvanized steel.

What's galvanized steel and why?

We've all heard of galvanized steel. It's a process to create a corrosion resistant layer of protective zinc on steel. It's extremely common, durable, and reliable. Galvanized steel is different in that it is processed at a much higher temperature than galvanized steel. At the higher temperature, the iron in the steel combines with the projective zinc layer to create a zinc-iron alloy coating. As a result, galvanized steel is harder and stronger than galvanized steel, easier to weld and the surface is a matte finish that's more consistent and easier to paint on.

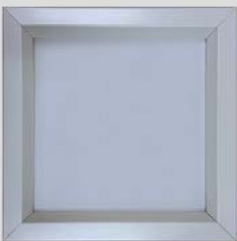

LITE KIT

We have an assortments of lite kites to choose from.

Let us know how you like the door.

Our lite kit frames are powder coated for improved corrosion resistance compared to conventional paint finishes. Powder coating is a process where charged powder is sprayed onto the grounded frames, binding evenly to the applied surface. It's then cured to create a robust surface finish that's durable and longer-lasting than conventional paint finishes.

TELL HARDWARE

Our selection of hardware gives you the security options you need.

Rest at ease knowing the door is secure.

Tell products are a smart way to minimize the risks of property damage and theft and help ensure safety in your modular buildings. For high-traffic, high-use applications, Tell locksets, door closers, exit devices and hardware are the right commercial solutions. Our products are proven performers, offering the ideal combination of quality, durability and security.

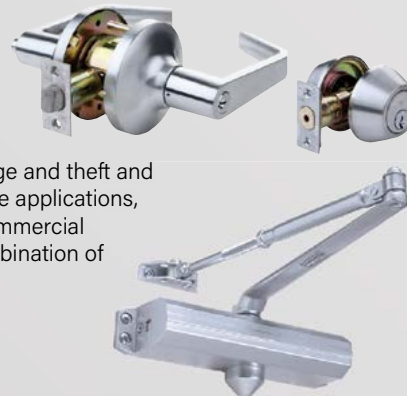

SPARTAN DOORS

ABOUT THE PRODUCT

The **Spartan Series Doors** are designed to meet the architectural requirements for hollow metal doors. This premium door construction combines the strength and dimensional stability of steel with the structural integrity of the polystyrene core. The continuous bonding of core to metal provides an attractive flat door, free of face welding marks. Windstorm Tests have proven that the Spartan door has integral high resistance to impact damage, low thermal conductivity, and high STC ratings. To meet application, specification and performance requirements, the Spartan offers a wide range of specifiable options including sizes, glass lite designs, hardware (mechanical, pneumatic, electrical) preparations and edge constructions.

Polystyrene core system enhances the structural integrity of the door, while significantly reducing the weight.

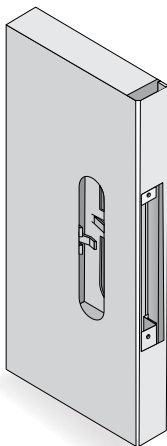
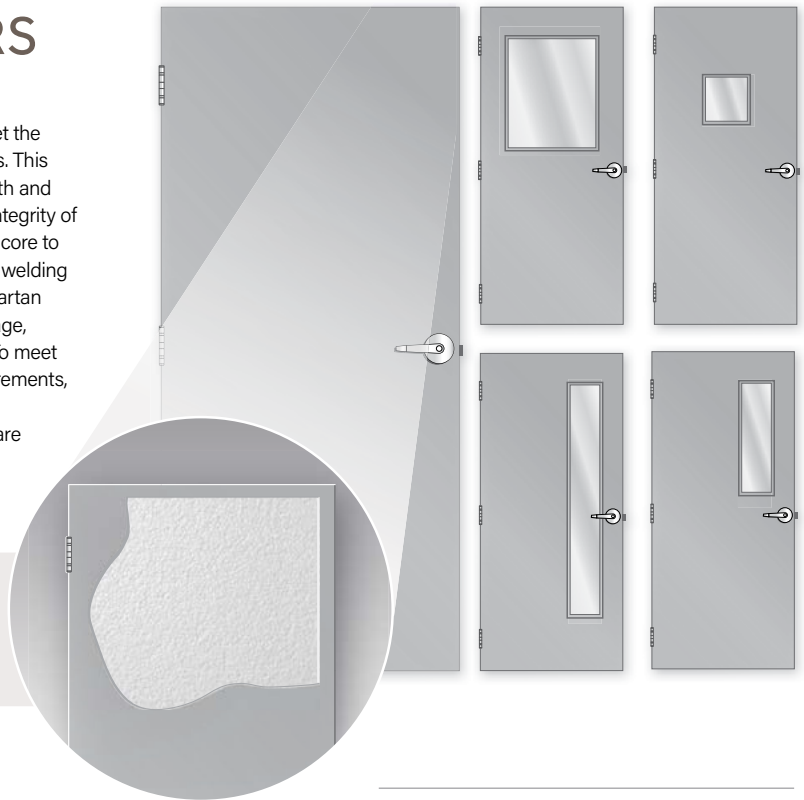

86 LOCK PREP
Optional with face prep

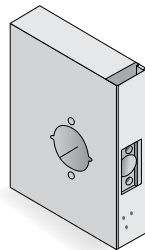

161L LOCK PREP

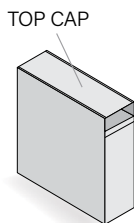

DOOR HEAD

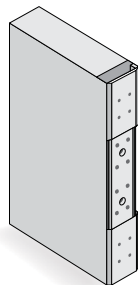

HINGE PREP



Our Spartan Doors and Frames line is proudly Made in Houston with US and global components.



TELL Manufacturing follows the same set of performance specifications as other door manufacturers, as set forth in the Steel Door Institute (SDI) requirements. And UL listed

GENERAL NOTES

1. Edge construction:

- Vertical edges (both hinge and lock) are square with a visible seam.
- Top and bottom edges are closed with inverted 18 - gage welded channels. Exterior applications require the addition of snap-in top caps to protect against the weather.

2. Cores available in the Spartan Door construction:

- Polystyrene, standard, for exterior applications in cold weather conditions.
- Polyurethane option, for exterior applications in extreme weather conditions.

3. Standard hardware preparations—standard mortised and reinforced for:

- Universal Hinge Preps- 4-1/2"(114mm) patented preparation which allows easy and quick field conversion from standard to heavy weight hinges.
- Locks- A multitude of standard lock preps are available. The most commonly used with a 4-7/8" (124mm) strike are 161, 61L and 86.

SPARTAN HOLLOW METAL DOORS

DOORS AND FRAMES

HOLLOW METAL

Spartan Doors and Frames are manufactured from high quality galvanized steel and are thoroughly cleaned inside and out to insure excellent corrosion resistance and paint adhesion. They come standard with a prime coat, ready to be finished.

Our Spartan Door is available in 18 and 16 gauge steel and the Spartan Frame is 16 gauge standard.



DOOR FEATURES

- Door** • 18 and 16 gauge Galvanized Steel
- Paint**
 - Prime painted standard
 - Other paint colors available
 - Custom colors are available, contact customer service
- Hinge Prep**
 - Non-handed 4-1/2" – 7 gauge hinge reinforcements, accommodates heavyweight hinges
- Fire Rated**
 - Up to 3 hours are certified by Underwriters Laboratories
- Channels**
 - 16 gauge inverted top and bottom channel
- Insulation**
 - Polystyrene core standard
 - Polyurethane option available
- Top Cap**
 - Installed steel cap standard
- Closer Prep**
 - 14 gauge reinforced steel, standard

The Spartan Frames are knock-down construction and are designed to be installed on standard and non-standard wall sizes over pre-finished or unfinished drywall.

FRAME FEATURES

- Frame**
 - 16 Gauge Galvanized Steel
 - Knockdown construction
 - Precision Mitered Corners
 - Easy Installation
- Paint**
 - Prime painted standard
- Closer Prep**
 - 14 gauge reinforced steel, standard
- Fire Rated**
 - Up to 3 hours are certified by Underwriters Laboratories
- Closer Prep**
 - 14 gauge reinforced steel, standard

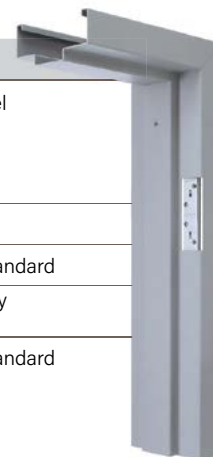

LOCKSET & DEADBOLT READY



CLOSER REINFORCEMENT



TAMPER RESISTANT HINGE

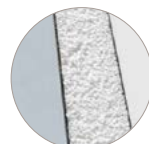

POLYSTYRENE INSULATED CORE



INVERTED TOP AND BOTTOM CHANNEL



STEEL CAP TOP STANDARD

DRYWALL FRAMES

STANDARD FEATURES

All Spartan Drywall Frames come with adjustable compression anchors in each jamb. These anchors provide a tight rigid fit in the opening.

- 16 gauge for 1 3/4" doors
- Precision fitted corners
- Galvannealed (standard)
- 7 gauge hinge reinforcements
- Heavy duty strike reinforcements
- Universal 4 1/2" hinge prep
- Fire rated up to 1 1/2 hours.
Available on frame openings up to 8'-0" high and 3'-8" wide single door, 7'-4" double door.
- Meets ANSI standards

TYPICAL BASE AND WALL ANCHORS

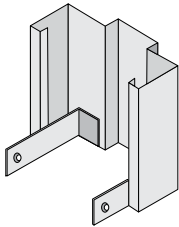

STRAP ANCHOR

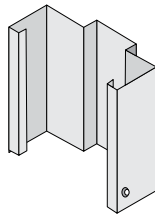

DIMPLE ANCHOR

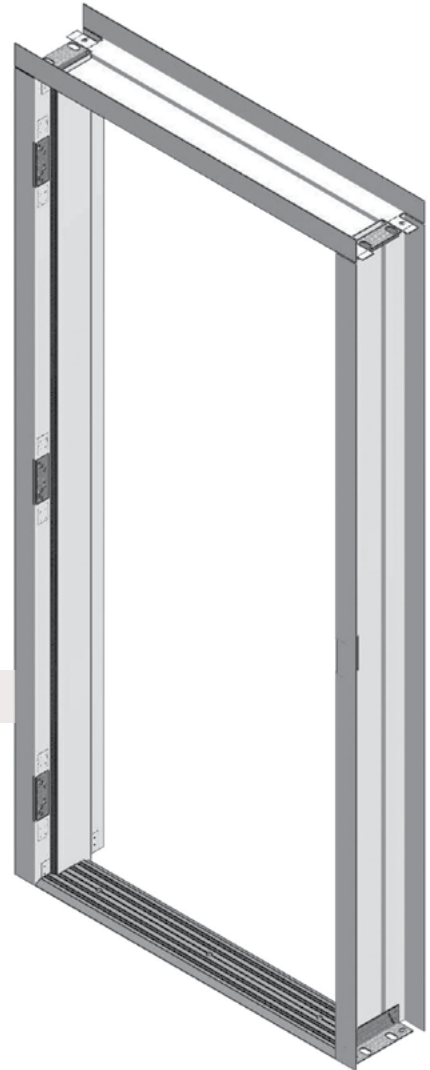

MASONRY FRAMES

STANDARD FEATURES

All Spartan Masonry Frames come with 1/2" returns. Masonry, Wood, and Existing Opening Anchoring (E.O.A.) systems are all available.

- 16 gauge for 1 3/4" doors
- Precision fitted corners
- Galvannealed (standard)
- 7 gauge hinge reinforcements
- Heavy duty strike reinforcements
- Fire rated up to 3 hours.
- Universal 4 1/2" hinge prep
- Meets ANSI standards

TYPICAL BASE AND WALL ANCHORS

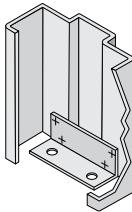

ONE PIECE WELDED BASED ANCHOR

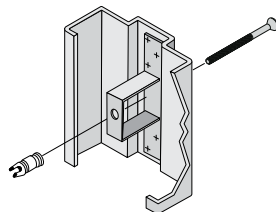

MASONRY WIRE ANCHOR

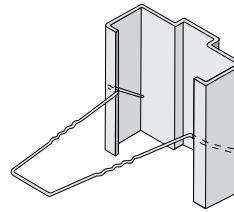

EXISTING OPENING ANCHOR (E.O.A.)

DOOR DIMENSIONS

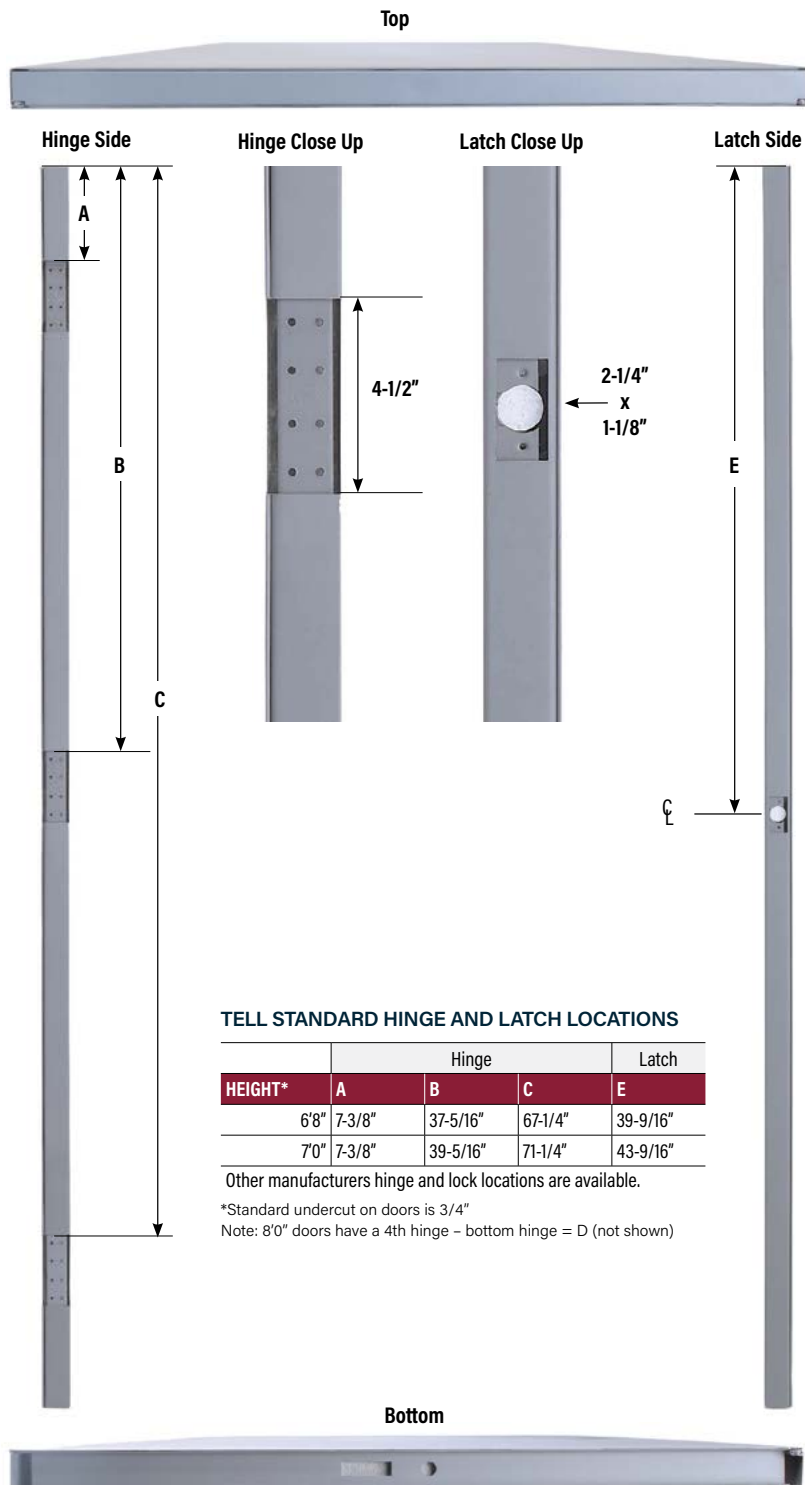

TELL STANDARD HINGE AND LATCH LOCATIONS

HEIGHT*	Hinge			Latch
	A	B	C	E
6'8"	7-3/8"	37-5/16"	67-1/4"	39-9/16"
7'0"	7-3/8"	39-5/16"	71-1/4"	43-9/16"

Other manufacturers hinge and lock locations are available.

*Standard undercut on doors is 3/4"

Note: 8'0" doors have a 4th hinge - bottom hinge = D (not shown)

DETAILS

- Insulated with polystyrene core
- Non-handed
- Galvannealed (standard)
- Fire rated up to 3 hours
- 7 gauge hinge reinforcements
- Reinforced 161 lock prep
- Closer reinforcement (standard)
- Meets ANSI standards
- Universal 4 1/2" hinge prep
- Inverted top and bottom channel
- Installed steel cap standard
- Available with polyurethane core

PAINT OPTIONS



NOTE: Actual colors may vary from those shown due to limitations of the printing production process.

ABBREVIATION LEGEND

ABBREVIATION	EXTENDED DESCRIPTION
1 PNL	1 PANEL
2 PNL	2 PANEL
3 PNL	3 PANEL
4 PNL	4 PANEL
5 PNL	5 PANEL
6 PNL	6 PANEL
3LT	3 LITE
5LT	5 LITE
9LT	9 LITE
12LT	12 LITE
15LT	15 LITE
3/4V	3/4 VIEW
ADA	AMERICANS WITH DISABILITIES ACT
ADJ	ADJUSTABLE
ADJ OI	ADJUSTABLE OPEN IN
BV	BEVELED
EM	EXTERNAL MUNTIN
FBG	FIBERGLASS
FJ	FINGER-JOINT
FLT	FLAT
FV	FULLVIEW
HV	HALF VIEW
HZ	HORIZONTAL
IM	INTERNAL MUNTIN
LT	LITE
LVR	LOUVER
MINI	MINI-BLIND
MTL	METAL
OI	OPEN IN
OO	OPEN OUT
PNL	PANEL
RND	ROUND
SDL	SIMULATED DIVIDED LITE
SL	SIDELIGHT
SQ	SQUARE
V-GRV	V-GROOVE



MM012425DC